

SAMSUNG



USER MANUAL

SM-R325

SAMSUNG

Printed in Korea
GH68-48465A Rev.1.1
English (EU), 11/2017



About the Gear VR

The Samsung Gear VR allows you to enjoy 2D, 3D, and 360-degree content by connecting it with your mobile device.

You can also view webpages and your own 360-degree images or videos. Connect other devices, such as controllers (included), game controllers, or headsets (sold separately), with the mobile device for a more immersive experience.



Table of Contents

Read me first

Getting started

- 7 Package contents
- 8 Device layout
- 17 Connecting the mobile device and wearing the Gear VR
- 34 Preparing the controller for use
- 39 Installing the Gear VR app (Oculus) and connecting the controller

Basics

- 48 Using the Gear VR's touchpad
- 50 Using the controller
- 53 Moving the pointer or the screen
- 54 Selecting items
- 54 Using the Universal menu
- 57 Downloading apps and content
- 58 Viewing notifications received on the mobile device

Viewing content

- 60 Viewing content on the Oculus Home screen
- 64 Viewing content on the mobile device
- 67 Viewing online content

Health and safety warnings

Safety information

Appendix

- 90 Troubleshooting

Read me first

- Please read this manual before using the Samsung Gear VR (also referred to as Gear VR) to ensure safe and proper use.
- To prevent injury or damage to your devices, read the health and safety warnings and information before using the Gear VR.
- Use the Gear VR for its intended purpose only. Using the Gear VR for other purposes may result in injury.
- The Gear VR cannot be operated by itself. To use the Gear VR, connect a mobile device to it. Visit www.samsung.com to see a list of compatible mobile devices.
- To use a mobile device with the Gear VR, upgrade the mobile device's software to the latest version.
- Some languages or content may not be available depending on the region or network.
- To view the open source licence for the Gear VR, refer to opensource.samsung.com.

Instructional icons



Warning: situations that could cause injury to yourself or others



Caution: situations that could cause damage to your device or other equipment



Notice: notes, usage tips, or additional information

Getting started

Package contents

Check the product box for the following items:

- Gear VR, top strap, main strap, Micro USB device holder (for replacement), controller, wrist strap, controller holder, two AAA batteries, and user manual





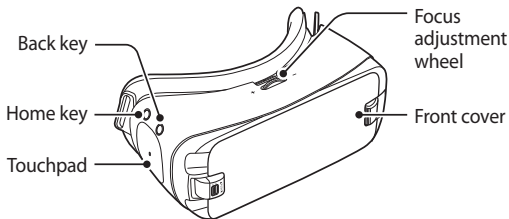

- The items supplied with the device and any available accessories may vary depending on the region or service provider.
- The supplied items are designed only for this device and may not be compatible with other devices.
- Appearances and specifications are subject to change without prior notice.
- Use only Samsung-approved accessories. Using unapproved accessories may cause performance problems and malfunctions that are not covered by the warranty.
- Availability of all accessories is subject to change depending entirely on manufacturing companies. For more information about available accessories, refer to the Samsung website.

Device layout

Gear VR



Touchpad and keys	Function
 Touchpad	<ul style="list-style-type: none">• Tap to select an item. You can move to the next or previous item by swiping forwards or backwards. For more information, refer to Using the Gear VR's touchpad. (p. 48)

Touchpad and keys	Function
 Home	<ul style="list-style-type: none">• Press to return to the Oculus Home screen.
 Back	<ul style="list-style-type: none">• Press to return to the previous screen.• Press and hold to open the Universal menu. You can view the status of the Gear VR and configure settings.
-  + Focus adjustment wheel	<ul style="list-style-type: none">• Rotate to focus by adjusting the distance between the mobile device and the Gear VR's lenses.

Getting started

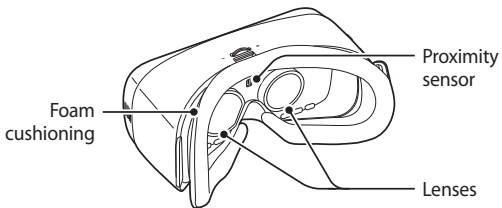
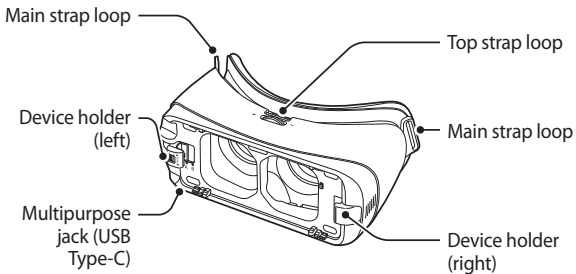



- The Gear VR does not require charging as it is powered using the mobile device's battery.
- You can charge your mobile device by connecting a charger to the Gear VR's multipurpose jack. Use only Samsung-approved chargers. Unapproved chargers can cause the mobile device's battery to explode or damage your devices.
 - If you use a Micro USB charger, connect a Micro USB connector before plugging the charger into the Gear VR. The Micro USB connector is sold separately and is only for battery charging.

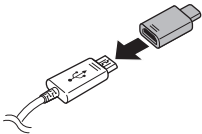



- If you use the Gear VR while the charger is connected to the Gear VR's multipurpose jack, it is powered by the charger and does not use the mobile device's battery. When you use content that has high power demand (more than 1 A) while the charger is connected, the Gear VR uses two power sources. In high power demand situations, the Gear VR is powered by the charger and the mobile device's battery at the same time.
- If the Gear VR is not used while the charger is connected, the mobile device's battery will be charged.
- If the Gear VR is connected to or disconnected from the charger while the Gear VR is being used, the image on the screen may be briefly inactive. During this period, the screen recalibrates and the Gear VR may not recognise your head movements.
- If you reconnect the mobile device to the Gear VR while the charger is connected, the Gear VR may not recognise the mobile device. Remove the charger before you connect the mobile device.





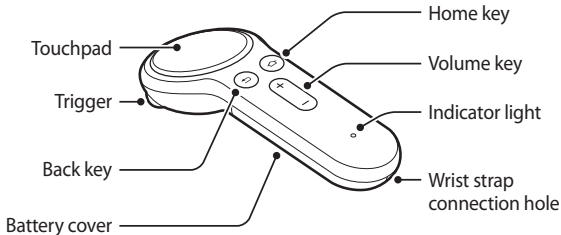

- To save energy, unplug the charger when not in use. The charger does not have a power switch, so you must unplug the charger from the electric socket when not in use to avoid wasting power. The charger should remain close to the electric socket and easily accessible while charging.

Controller

You can connect the controller to a mobile device connected with a Gear VR via Bluetooth. Control various Gear VR features with the controller keys and touchpad.



Touchpad and keys	Function
 Touchpad	<ul style="list-style-type: none">• Press to select an item. You can move to the next or previous item by swiping to the left or right. For more information, refer to Using the controller. (p. 50)
 Home	<p>When the controller is not connected with a Gear VR:</p> <ul style="list-style-type: none">• Press and hold to enter Bluetooth pairing mode. <p>When the controller is connected with a Gear VR:</p> <ul style="list-style-type: none">• Press to return to the Oculus Home screen.• Press and hold to reorient the controller's pointer direction when it is off-centre.

Touchpad and keys	Function
 Back	<ul style="list-style-type: none">• Press to return to the previous screen.• Press and hold to open the Universal menu. You can view the status of the Gear VR and configure settings.
 Volume	<ul style="list-style-type: none">• Press to adjust the Gear VR volume.
 Trigger	<ul style="list-style-type: none">• Press to select an item or use it as a trigger when playing certain games. Its function may vary depending on the launched apps.

Indicator light

Colour	Status
Flashes red, green, and blue	<ul style="list-style-type: none">• The controller is in Bluetooth pairing mode.
Flashes blue three times	<ul style="list-style-type: none">• Bluetooth is connected.
Flashes blue one time	<ul style="list-style-type: none">• Sleep mode is deactivated.

Band and mode

Band and mode	Output power
Bluetooth 2.4 GHz	13 dBm

Declaration of Conformity

Samsung Electronics declares that this device complies with the essential requirements and relevant provisions of Directive 2014/53/EU.

Go to www.samsung.com/mobile_doc to view the Declaration of Conformity.

Connecting the mobile device and wearing the Gear VR



Do not look directly at bright light while you are wearing the Gear VR without the mobile device inserted. Doing so may damage your eyesight or cause blindness.

Getting started



- Do not put on the Gear VR when you are wearing glasses. Doing so may cause facial injuries. If you need corrective lenses, it is recommended that you wear contact lenses when using the Gear VR.
- If you are farsighted or there is a big difference between your left and right eyes' vision, wear corrective lenses before using the Gear VR.



To avoid damage to the Gear VR or mobile device

- Do not leave the Gear VR in direct sunlight. Exposure to direct sunlight can damage the Gear VR or mobile device.
- Do not expose the lenses to external light sources including sunlight and lasers, etc., which may cause the damage on the device.
- Store components in their storage case when not in use to minimise unintentional damage or environmental exposure.



- If factory lens protectors are pre-installed on the Gear VR, remove the lens protectors before you use the Gear VR so you can see clearly.
- Keep the lenses clean and protect them from getting scratched. If the lenses get dirty or steam up, clean them with the lens cleaning cloth.
- The foam cushioning may get dirty if your face is sweating while you are wearing the Gear VR. Do not try to wash the foam cushioning. Remove the polluted foam cushioning from the Gear VR and attach a new one.
- The touchpad works only while you are wearing the Gear VR.
- A proximity sensor inside the Gear VR detects the position of your face. When wearing the Gear VR, the mobile device's screen will turn on and the Gear VR's touchpad will be activated. When you are not wearing the Gear VR, do not place objects near the proximity sensor inside the Gear VR. Doing so may cause the mobile device's screen to remain on and drain its battery.

Connecting straps

Insert the ends of the straps through the strap loops on the Gear VR and use the velcro to fasten each end.

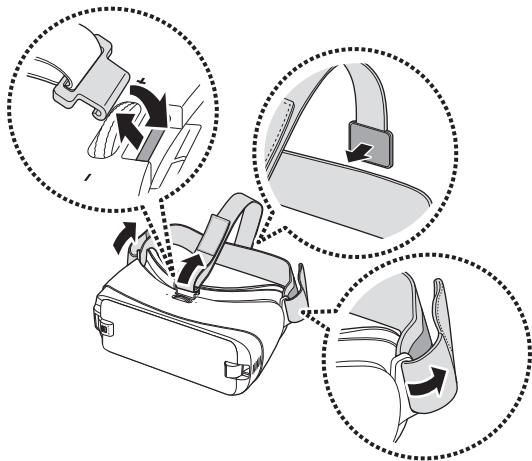

Removing straps

Remove the top strap by pulling its loop towards the foam cushioning. Then, remove the main strap from the Gear VR.

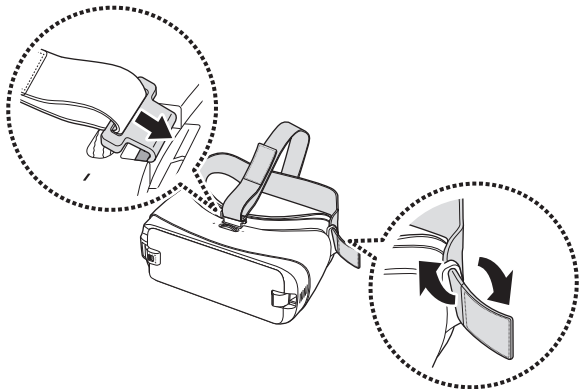

Removing the front cover

Pull the device holder (right) to the right (1) then remove the front cover (2).

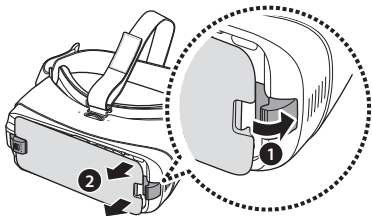

Replacing the device holder

The USB Type-C device holder is attached to the Gear VR by default. If your mobile device's multipurpose jack is USB Type-C, you can connect the mobile device to the Gear VR. If your mobile device's multipurpose jack is Micro USB, replace the device holder with the Micro USB device holder before connecting your mobile device to the Gear VR.

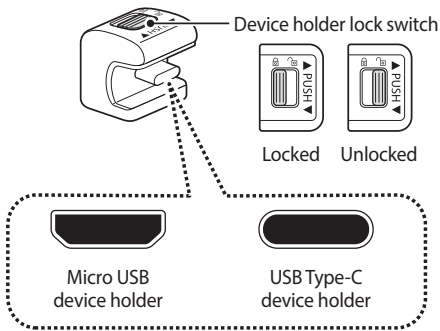

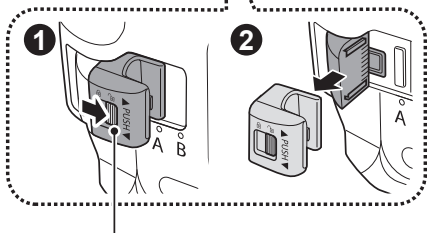
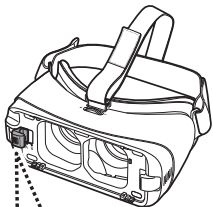

Getting started

- 1 Slide the lock switch to the  position and remove the device holder from the Gear VR.



Lock switch

- 2 Select another device holder. While the lock switch is in the  position, slide the device holder into the holder slot. Then, lock the holder by sliding the lock switch to the  position.

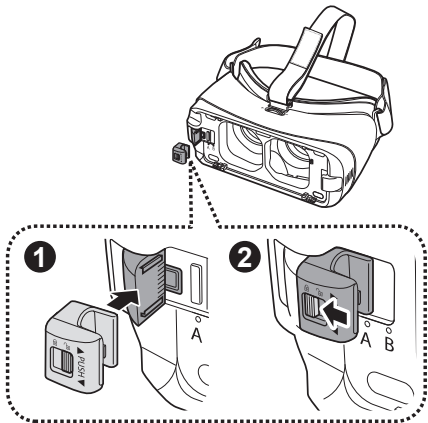

Getting started



Do not slide the device holder into the holder slot while the lock switch is in the  position. This may damage the lock switch's latch.

Connecting the mobile device

- 1 Pull the device holder (right) to the right thoroughly (1). Then, push the device holder (left) gently (2) and slide it to position A or B (3) depending on the size of the mobile device's screen you want to use.

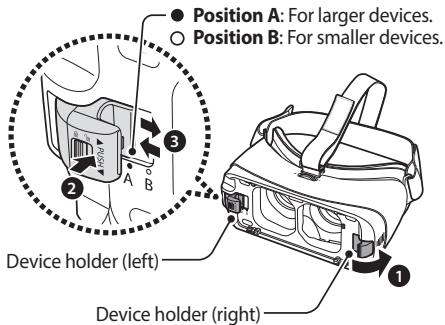

- 2 Unlatch the device holder (left).

Getting started

- 3 While the mobile device is on, connect it to the connector on the device holder (1).

The mobile device will emit a sound when it is connected to the Gear VR properly.

Insert the mobile device into the centre of the Gear VR and gently push the mobile device until it locks into place (2). The device holder (right) will return to the previous position and hold the mobile device (3).

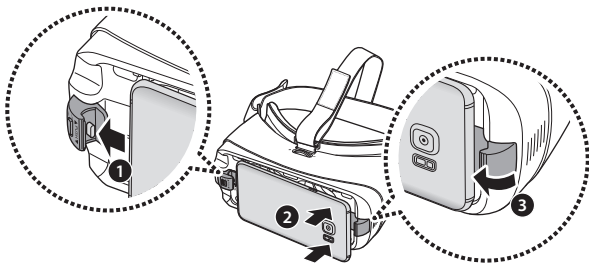



- Do not forcefully insert the connector into the mobile device. Doing so may damage the connector.
- Do not twist or bend the Gear VR's connector when you connect or disconnect the mobile device. Doing so may damage the connector.
- Ensure that you lock the device holder by sliding the lock switch to the  position. If not, the mobile device may accidentally separate from the Gear VR and be damaged.
- Push the mobile device into the Gear VR firmly until it locks in place. If it is not securely locked, the mobile device may accidentally separate from the Gear VR and be damaged.
- If you insert the mobile device tilted to one side, it may cause discomfort.

Getting started

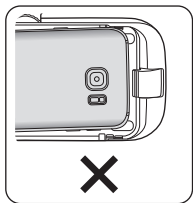
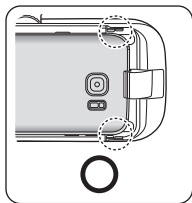

If the sound is not emitted when you insert the Gear VR's connector into the mobile device, the Gear VR may not have recognised it. Unlock the mobile device's screen before using the Gear VR.

Wearing the Gear VR

Place the Gear VR on your head and adjust the length of the top strap and the main strap.





Do not walk or drive while wearing the Gear VR. Always be aware of your surroundings while using the Gear VR to avoid injuring yourself or others.



- Wear the Gear VR properly. If you wear the Gear VR tilted to one side, it may cause discomfort.
- If the screen shifts to the left or right, check if the device holder (left) is in the correct position. Reconnect your mobile device after sliding the device holder (left) to position A or B according to the size of your mobile device's screen.
- When the screen is tilted, adjust the Gear VR until the screen becomes clear.
- To use a headset or a Bluetooth headset while using the Gear VR, connect it to your mobile device before connecting the mobile device to the Gear VR. Headsets and Bluetooth headsets are sold separately.
- To control the Gear VR with your controller, connect the controller to the mobile device you attached to the Gear VR. (p. 42)

Separating the mobile device

Separate the mobile device from the Gear VR when you finish using it.

Pull the device holder (right) to the right (1), and remove the mobile device (2).

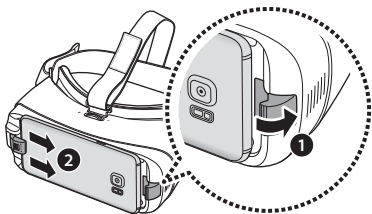



Replace the front cover when you finish using the Gear VR.

Preparing the controller for use

Connecting the wrist strap

When you connect the wrist strap to your controller, you can use the controller safely without dropping it.

- 1 While pressing  on the backside of the controller, slide the battery cover in the direction shown below to open it.

 Do not bend or twist the battery cover excessively. Doing so may damage the battery cover.

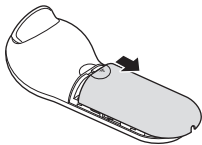

- 2 Insert the wrist strap loop into the wrist strap connection hole and attach it to the hook to secure it.

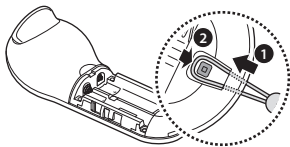

Installing the batteries

- 1 Insert batteries with the positive and negative terminals properly aligned with the + and - symbols on the controller.

Getting started

- 2 Place the battery cover on the controller and slide the battery cover back until it clicks back into place.

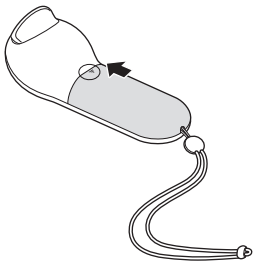

- If the indicator light flashes red while using the controller, replace the batteries.
- Do not recharge the provided batteries (AAA batteries).

Using the controller holder

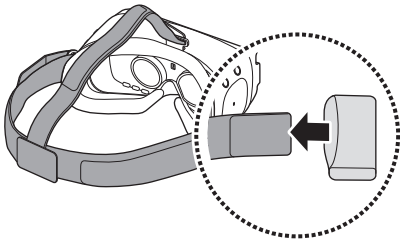

You can attach the controller holder to the Gear VR's main strap to store your controller when not using it.

- 1 Thread the Gear VR's main strap through the controller holder.

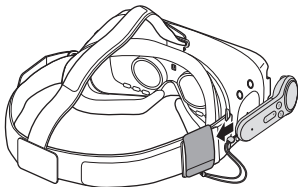

- Put your controller in the controller holder to store it.



-  Insert the controller into the controller holder properly. If it is not securely inserted, the controller may accidentally separate from the controller holder and become damaged.
-  If you do not use the controller for an extended period, store the controller after removing the batteries.

Installing the Gear VR app (Oculus) and connecting the controller

To use the Gear VR, you must manually install the Gear VR app (Oculus). Also, connect the controller to your mobile device before controlling the Gear VR. When you connect the mobile device to the Gear VR for the first time, the Gear VR app (Oculus) installation and controller connection will start automatically.



- Before installing the app, ensure that the mobile device is connected to a Wi-Fi or mobile network.
- The installation method or screens may differ depending on the app version.

- 1 Connect the mobile device to the Gear VR.
- 2 When a voice prompt requests you to separate the mobile device from the Gear VR, remove the mobile device.

The Gear VR app (Oculus) installation screen will appear on the mobile device.

Getting started

- 3 On the Gear VR app (Oculus) installation screen, tap **START**.
- 4 Read and agree to the health and safety warnings, and the terms and conditions in the End User Licence Agreement (EULA), and then tap **NEXT**.
- 5 Tap **INSTALL** to install the default VR apps.
- 6 To create an Oculus account using your Facebook account, tap **Continue Using Facebook**. If you continue with your Facebook account, you can sync your Facebook friends, stream live videos on Facebook, and more.

To create an Oculus account, tap **Create account**. If you already have an Oculus account, tap **Sign in** and sign in to it. Your Oculus account will be used when using apps and content provided by Oculus.
- 7 Set a payment method for making payments when you download paid VR apps or games from the Oculus Store.

8 Follow the on-screen instructions to connect the controller and choose the hand you will use the controller with.



- If the controller is not detected, press and hold the controller's Home key to re-enter Bluetooth pairing mode.
- The next time you connect the controller, you can connect it to your mobile device on your mobile device's setting screen or the Gear VR app (Oculus). (p. 42, p. 43)

9 Reconnect your mobile device to the Gear VR and place the Gear VR on your head.

When you sign in to your Oculus account, a tutorial will start. After viewing the tutorial, the Oculus Home screen will appear. Control the Gear VR with the controller's keys and touchpad.



- A proximity sensor inside the Gear VR detects the position of your face. When you wear the Gear VR, the screen unlocks and you can use the touchpad.
- The 3D viewing experience may vary depending on your visual acuity.
- Unlock your mobile device before using the Gear VR.
- If the screen appears tilted or skewed while using the Gear VR, take it off. Then, place the Gear VR on a flat surface with the lenses facing forwards and the Focus adjustment wheel at the top. Wait 5–7 seconds before using it again.

Connecting the controller with the Gear VR app (Oculus)

- 1 Press and hold the controller's Home key to enter Bluetooth pairing mode.

The indicator light will flash red, green, and blue.

- 2 On the Gear VR app (Oculus), tap  and select the controller menu to connect the controller.

The indicator light will flash blue three times.



The way for connecting the controller can be changed depending on the Oculus service.

- 3 Reconnect your mobile device to the Gear VR and wear the Gear VR.

Control the Gear VR with the controller's keys and touchpad.

Connecting the controller via Bluetooth



You can connect the controller via Bluetooth only on mobile devices running Android 6.0 or higher. If you cannot connect the controller via Bluetooth, connect it with the Gear VR app (Oculus).

- 1 Press and hold the controller's Home key to enter Bluetooth pairing mode.

The indicator light will flash red, green, and blue.

Getting started

- 2 After activating your mobile device's Bluetooth feature, tap **Gear VR Controller(0000)** on the list of available devices to complete Bluetooth pairing.

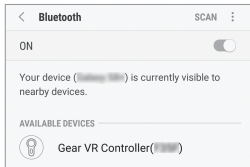

The indicator light will flash blue three times.

-  The PIN for the controller is the four-digit number in parenthesis displayed on the mobile device's Bluetooth settings screen. The number differs depending on the controller.

- 3 Reconnect your mobile device to the Gear VR and place the Gear VR on your head.
Control the Gear VR with the controller's keys and touchpad.

Disconnecting and reconnecting the controller

If you remove the Gear VR from your head or the current connection ends, the controller enters sleep mode. Press the controller's trigger, touchpad, or any keys to deactivate sleep mode and re-enter Bluetooth pairing mode.

The controller will be reconnected to the previous mobile device automatically.



- If the controller and the mobile device are not kept within the Bluetooth connection range, the controller will be disconnected.
- If the batteries are removed from the controller or the Bluetooth feature is deactivated in the mobile device, the controller will be disconnected.
- If the Bluetooth connection is lost due to a problem with the connected mobile device, access the Bluetooth menu on the mobile device to pair the devices again.
- If your controller is not functioning properly, take it and the Gear VR to a Samsung Service Centre.

Notices for using Bluetooth

Bluetooth is a wireless technology standard that uses a 2.4 GHz frequency to connect to various devices over short distances. It can connect and exchange data with other Bluetooth enabled devices, such as mobile devices, computers, printers, and other digital home appliances, without connecting via cables.

- To avoid problems when connecting your controller to another device, place the devices close to each other.
- Ensure that your controller and the other Bluetooth device are within the maximum Bluetooth range. The distance may vary depending on the environment the devices are used in.
- Ensure that there are no obstacles between the controller and a connected device, including human bodies, walls, corners, or fences.
- Do not touch the Bluetooth antenna of a connected device.
- Bluetooth uses the same frequency as some industrial, scientific, medical, and low power products and interference may occur when making connections near these types of products.

- Some devices, especially those that are not tested or approved by the Bluetooth SIG, may be incompatible with your controller.
- Do not use the Bluetooth feature for illegal purposes (for example, pirating copies of files or illegally tapping communications for commercial purposes).

Basics

Using the Gear VR's touchpad

The touchpad is located under the Back key and the Home key. Use the touchpad to select items or to control the Gear VR.

 To avoid damaging the Gear VR's touchpad, do not tap it with anything sharp.

-  • A proximity sensor in the Gear VR detects the position of your face and activates the touchpad. When you are not wearing the Gear VR, the touchpad will not work.
- The touchpad functions may vary by app.



Tapping

- Select an item.
- While playing a video, show available features.



Swiping forwards or backwards

- Move to the next or previous item.
- Scroll right or left on a list.
- Reject an incoming call.

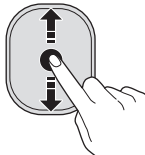

Swiping upwards or downwards

- Scroll up or down on a webpage or list.
- While viewing an image, enlarge or reduce its size.



Some apps may not support upwards or downwards swiping actions.

Using the controller

Control the Gear VR by moving your wrist in any direction to move the pointer and use the touchpad to select items.



To avoid damaging the controller's touchpad, do not tap it with anything sharp.



- To use the controller, connect it to your mobile device.
- The controller functions may vary by app.



Pressing

- Select an item.
- While playing a video, show available features.

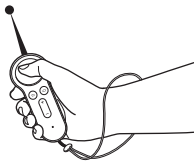

Moving

- Move your wrist to move the pointer left, right, up, and down on the screen.

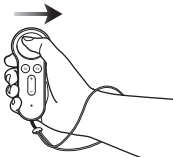

Swiping to the left or right

- Move to the next or previous item.
- Scroll right or left on a list.
- Reject an incoming call.

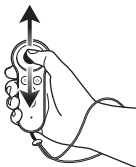

Swiping upwards or downwards

- Scroll up or down on a webpage or list.
- While viewing an image, enlarge or reduce its size.



Some apps may not allow you to use the swipe function.

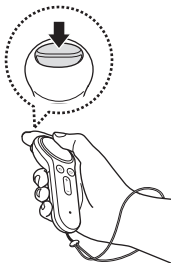

Using the trigger

- Press to select an item or use it as a trigger when playing certain games. Its function may vary depending on the launched apps.

Moving the pointer or the screen

The Gear VR recognises your head movements. Move your head in any direction to move the pointer or the screen.

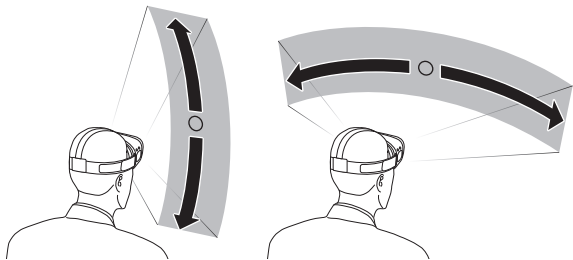

To control the Gear VR with your controller, move your wrist in any direction to move the pointer.



- The pointer is located in the centre of the screen. Some apps and content may not display the pointer at all times.
- Depending on the app, there may be screen movement restrictions.

Selecting items

You can select items by moving your head and then tapping the Gear VR's touchpad. You can also select items by moving your controller with your wrist and then pressing the touchpad.







Move the pointer to the item you want. When the border of the item is highlighted, tap the Gear VR's touchpad or press the controller's touchpad to select it.

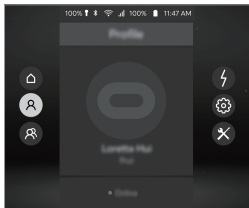







Using the Universal menu

You can use the Universal menu to configure settings for the Gear VR and to capture the Gear VR's screen. Also, you can view the current time, remaining battery power, and more.

Press and hold the Gear VR's Back key or the controller's Back key to open the Universal menu. To return to the previous screen, press the Gear VR's Back key or the controller's Back key.



-  : Return to the Oculus Home screen.
-  : View your Oculus account profile.
-  : View your friends list and check the friend request. You can invite your friends to the party room and play games and watch videos together.
-  : View incoming call and message notifications.
-  : Display setting options.
 -  : Adjust the volume.
 -  : Adjust the brightness.

- : Align the screen with the current direction you are facing.
- : Choose the hand you will use the controller with.
- : Set the Gear VR to turn pop-up messages on or off for incoming calls and notifications.
- : Activate or deactivate the Bluetooth feature.
- : Activate or deactivate the Wi-Fi feature.
- : Display utility options.
 - : Capture the Gear VR's screen.
 - : Record the Gear VR's screen.
 - : Activate the mobile device's rear camera to see outside the Gear VR. To deactivate the camera, select the **Turn Camera Off** icon.



- These features may not be available in some apps to protect their copyright.
- The Universal menu screen may appear differently depending on the Oculus service.

Downloading apps and content

Launch the Oculus Store app and download various apps and content, such as 360-degree videos or photos.

On the Oculus Home screen, select **Store**. Select the app or content you want to download. Then, select **Free** or select the button that shows the app's price, then follow the on-screen instructions to confirm the download.

Removing apps

To remove a downloaded app, select **Library** →  next to the app you want to delete. Select **Uninstall**.

Viewing notifications received on the mobile device

Viewing caller information or rejecting calls

If you receive a call while you are using the Gear VR, a pop-up message is displayed on the screen. You can view the caller information or reject the call.

To answer a call, separate the mobile device from the Gear VR and answer the call on the mobile device

To reject a call, swipe backwards or forwards on the Gear VR's touchpad or swipe to the left or right on the controller's touchpad.



The mobile device may become hotter than normal when it is used with the Gear VR. This situation occurs especially if you use the device to watch video or play games for an extended period. Answering a call when the mobile device is hot may cause minor burns to your face or ear. To avoid burns, remove the mobile device and wait for it to cool down. If you have to answer calls while it is still hot, connect a headset or use the speakerphone.



The Gear VR blocks pop-up messages for incoming calls when you block pop-up messages for incoming calls or other notifications. You can turn on pop-up messages in the Universal menu. (p. 56)

Viewing notifications

While using the Gear VR, you can check general notifications, such as events, messages, and alarms. When a notification comes in, a pop-up message is displayed on the screen. To see more notification details, check them on the mobile device after you separate it from the Gear VR.



The Gear VR blocks pop-up messages for notifications when you block pop-up messages for incoming calls or other notifications. You can turn on pop-up messages in the Universal menu. (p. 56)

Viewing content

Viewing content on the Oculus Home screen

Oculus Home screen

When you connect your mobile device to the Gear VR and wear the Gear VR, you will see the Oculus Home screen. On the Oculus Home screen, select an app or content to view various 2D, 3D, or 360-degree content. While using the Gear VR, press the Gear VR's Home key or the controller's Home key to return to the Oculus Home screen.

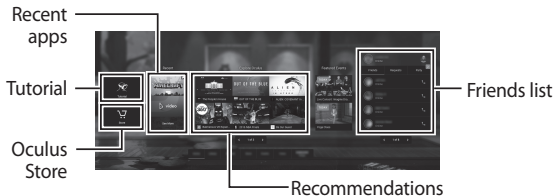

The Oculus Home screen may appear differently depending on the Oculus service.

Library

View the content and apps you downloaded from the Oculus Store. On the Oculus Home screen, select **Library**. Move to the content or app you want to use and select it.

Oculus Video



Enjoy various videos and 3D movies in your own virtual movie theatre.

You can also view 360-degree videos, as well as 2D or 3D videos, saved in your mobile device.

If the Oculus Video app is not installed as a default app, download it from the Oculus Store.

- 1 On the Oculus Home screen, select **Library** → **Oculus Video**.
- 2 Select a category and a video.
- 3 Move your head in any direction or use the controller to watch the videos from various angles.
Swipe backwards or forwards on the Gear VR's touchpad or swipe to the left or right on the controller's touchpad to rewind or fast-forward.

While watching videos, tap the Gear VR's touchpad or press the controller's touchpad to use the following features:

- : Pause and resume playback.
- : Return to the playlist.

Oculus 360 Photos

View recommended 360-degree images, 3D art images, and other various images.

You can also view 360-degree images saved in your mobile device.

If the Oculus 360 Photos app is not installed as a default app, download it from the Oculus Store.

- 1 On the Oculus Home screen, select **Library** → **Oculus 360 Photos**.
- 2 Select a category and an image.
- 3 Move your head in any direction to view the images from various angles.

Swipe backwards or forwards on the Gear VR's touchpad or swipe to the left or right on the controller's touchpad to view the previous or next image.

Viewing content on the mobile device

View images and videos saved in your mobile device. You can also enjoy 2D and 3D videos with subtitles and stereophonic sound, as well as 360-degree content captured by 360 cameras, such as the Gear 360.

If the Samsung Gallery app is not installed as a default app, download it from the Oculus Store.



On the Oculus Home screen, select **Library** → **Samsung Gallery**.





Playing videos

Select a video and play it.

Swipe backwards or forwards on the Gear VR's touchpad or swipe to the left or right on the controller's touchpad to rewind or fast-forward.

While watching videos, tap the Gear VR's touchpad or press the controller's touchpad to use the following features:

- : Pause and resume playback.
- : Move to the previous or next video.
- : Select a video from the video list.

-  : Select a view mode.
 - **2D**: View the video in 2D.
 - **360°**: View 360-degree videos.
 - **180°**: View 180-degree videos.
 - **3D SBS/3D TB/360° 3D SBS/360° 3D TB/180° 3D SBS/180° 3D TB**: View the 3D video in 3D.
-  : Select whether to display subtitles.
-  : Access additional options.
 -  : Reposition the screen.
 -  : Adjust the brightness of the background.

Viewing images







Select an image.

Swipe backwards or forwards on the Gear VR's touchpad or swipe to the left or right on the controller's touchpad to view the previous or next image.

To enlarge or reduce the size of the image, swipe upwards or downwards on the Gear VR's touchpad or controller's touchpad.

To reorient the screen in the direction you are currently facing, tap the Gear VR's touchpad or press the controller's touchpad. You can also move the screen by moving your head while tapping or pressing and holding the touchpad. Alternatively, press the Gear VR's Back key twice.

While viewing images, tap the Gear VR's touchpad or press the controller's touchpad to use the following features:

-  : View the next or previous image.
-  : View the images as a slide show.
-  : Select the view mode.
 - **2D**: View 2D images.
 - **360**: View 360-degree images.
 - **Panorama**: View panorama images.
-  : Access additional options.
 -  : Reposition the screen.
 -  : Adjust the brightness of the background.
 -  : Rotate the image.

Viewing online content

Using the Samsung Internet app, you can view Internet content and videos on webpages.

Download the Samsung Internet app from the Oculus Store and launch the app to view online content.

Health and safety warnings

- These health & safety warnings are periodically updated for accuracy and completeness. Check www.oculus.com/warnings for the latest version.



HEALTH & SAFETY WARNINGS: To reduce the risk of personal injury, discomfort or property damage, please ensure that all users of the Gear VR read the warnings below carefully before using the Gear VR.



Before Using the Gear VR

- Read and follow all setup and operating instructions provided with the Gear VR.
- Review the hardware and software recommendations for use of the Gear VR. Risk of discomfort may increase if recommended hardware and software is not used.

- Your Gear VR is not designed for use with any ineligible device, accessory and/or software. Use of an ineligible device, accessory and/or software may result in injury to you or others, and may cause performance issues or damage to your system and related services.
- A comfortable virtual reality experience requires an unimpaired sense of motion and balance. Do not use the Gear VR when you are tired, need sleep, are under the influence of alcohol or drugs, are hung-over, have digestive problems, are under emotional stress or anxiety, or when suffering from cold, flu, headaches, migraines, or earaches, as this can increase your susceptibility to adverse symptoms.
- We recommend seeing a doctor before using the Gear VR if you are pregnant, elderly, have pre-existing binocular vision abnormalities or psychiatric disorders, or suffer from a heart condition or other serious medical condition.



Seizures

Some people (about 1 in 4000) may have severe dizziness, seizures, epileptic seizures or blackouts triggered by light flashes or patterns, and this may occur while they are watching TV, playing video games or experiencing virtual reality, even if they have never had a seizure or blackout before or have no history of seizures or epilepsy. Such seizures are more common in children and young people under the age of 20. Anyone who has had a seizure, loss of awareness, or other symptom linked to an epileptic condition should see a doctor before using the Gear VR.



Children

The Gear VR should not be used by children under the age of 13, as young children are in a critical period in visual development. Adults should monitor children (age 13 and older) who are using or have used the Gear VR for any of the symptoms described below, and should limit the time children spend using the Gear VR and ensure they take breaks during use. Prolonged use should be avoided, as this could negatively impact hand-eye coordination, balance, and multi-tasking ability. Adults should monitor children closely during and after use of the Gear VR for any decrease in these abilities.



General Precautions

To reduce the risk of injury or discomfort you should always follow these instructions and observe these precautions while using the Gear VR.

- **Use Only In A Safe Environment:** The Gear VR produces an immersive virtual reality experience that distracts you from and completely blocks your view of your actual surroundings.
 - Always be aware of your surroundings before beginning use and while using the Gear VR. Use caution to avoid injury.
 - Use of the Gear VR may cause loss of balance.
 - Remember that the objects you see in the virtual environment do not exist in the real environment, so don't sit or stand on them or use them for support.
 - For the safest experience, remain seated or stationary when using the Gear VR.
 - Serious injuries can occur from tripping, running into or striking walls, furniture or other objects, so clear an area for safe use before using the Gear VR.

- Take special care to ensure that you are not near other people, objects, stairs, balconies, open doorways, windows, furniture, open flames, ceiling fans or light fixtures or other items that you can bump into or knock down when using—or immediately after using—the Gear VR.
- Remove any tripping hazards from the area before using the Gear VR.
- Remember that while using the Gear VR you may be unaware that people and pets may enter your immediate area.
- Do not handle sharp or otherwise dangerous objects while using the Gear VR.
- Never wear the Gear VR in situations that require attention, such as walking, bicycling, or driving.
- Make sure the Gear VR is level and secured comfortably on your head, and that you see a single, clear image.

Health and safety warnings

- Ease into the use of the Gear VR to allow your body to adjust; use for only a few minutes at a time at first, and only increase the amount of time using the Gear VR gradually as you grow accustomed to virtual reality. Looking around and using the input device when first entering virtual reality can help you adjust to any small differences between your real-world movements and the resulting virtual reality experience.
- Do not use the Gear VR while in a moving vehicle such as a car, bus, or train, as this can increase your susceptibility to adverse symptoms.
- Take at least a 10 to 15 minute break every 30 minutes, even if you don't think you need it. Each person is different, so take more frequent and longer breaks if you feel discomfort. You should decide what works best for you.
- The Gear VR may be equipped with a "pass-through" feature which permits you to temporarily see your surroundings for brief real world interaction. You should always remove the Gear VR for any situation that requires attention or coordination.

- Listening to sound at high volumes can cause irreparable damage to your hearing. Background noise, as well as continued exposure to high volume levels, can make sounds seem quieter than they actually are. Due to the immersive nature of the virtual reality experience, do not use the Gear VR with the sound at a high volume so that you can maintain awareness of your surroundings and reduce the risk of hearing damage.



Discomfort

- Immediately discontinue use if anyone using the Gear VR experiences any of the following symptoms: seizures; loss of awareness; eye strain; eye or muscle twitching; involuntary movements; altered, blurred, or double vision or other visual abnormalities; dizziness; disorientation; impaired balance; impaired hand-eye coordination; excessive sweating; increased salivation; nausea; lightheadedness; discomfort or pain in the head or eyes; drowsiness; fatigue; or any symptoms similar to motion sickness.

Health and safety warnings

- Just as with the symptoms people can experience after they disembark a cruise ship, symptoms of virtual reality exposure can persist and become more apparent hours after use. These post-use symptoms can include the symptoms above, as well as excessive drowsiness and decreased ability to multi-task. These symptoms may put you at an increased risk of injury when engaging in normal activities in the real world.
- Do not drive, operate machinery, or engage in other visually or physically demanding activities that have potentially serious consequences (i.e., activities in which experiencing any symptoms could lead to death, personal injury, or damage to property), or other activities that require unimpaired balance and hand-eye coordination (such as playing sports or riding a bicycle, etc.) until you have fully recovered from any symptoms.



- Do not use the Gear VR until all symptoms have completely subsided for several hours. Make sure you have properly configured the Gear VR before resuming use.
- Be mindful of the type of content that you were using prior to the onset of any symptoms because you may be more prone to symptoms based upon the content being used.
- See a doctor if you have serious and/or persistent symptoms.



Repetitive Stress Injury

Using the Gear VR can make your muscles, joints or skin hurt. If any part of your body becomes tired or sore while using the Gear VR, or if you feel symptoms such as tingling, numbness, burning or stiffness, stop and rest for several hours before using the Gear VR again. If you continue to have any of the above symptoms or other discomfort during or after play, stop using the Gear VR and see a doctor.



Interference with Medical Devices

The Gear VR contains magnets and can emit radio waves. These can affect the operation of nearby electronics, including cardiac pacemakers hearing aids and defibrillators. If you have a pacemaker or other implanted medical device, do not use the Gear VR without first consulting your doctor or the manufacturer of your medical device. Maintain a safe distance between the Gear VR and your medical devices, and stop using the Gear VR if you observe a persistent interference with your medical device.



Controller

- Your Gear VR may have come with a third-party controller.
- Consult the manufacturer for health and safety warnings for the controller.
- Always use included wrist straps with controllers to secure the controller to your wrist when in use.



Batteries

- **CHOKING HAZARD.** The controllers are not toys. They contain batteries, which are small parts. Keep away from children under 3.
- **DO NOT INGEST ANY BATTERY. CHEMICAL BURN HAZARD.**
- If a battery is swallowed, it can cause severe internal burns and potential perforation of esophagus in just 2 hours and can lead to death. Keep batteries out of reach of children.
- If the battery compartment does not close securely, stop using the product and keep it away from children.
- Risk of fire. Batteries could cause thermal event or leak if installed backwards, disassembled, overcharged, punctured, crushed, mixed with used or other battery types, or directly exposed to fire or high temperature. Do not recharge disposable batteries. Replace all batteries in a single device at the same time.
- Keep in original package until ready to use. Properly dispose of used batteries promptly.

Health and safety warnings

- Do not allow conductive materials to touch the battery terminals on the devices. Keep batteries dry and avoid water intrusion.
- Do not disassemble, pierce, or attempt to modify batteries.



Electrical Shock

To reduce risk of electric shock:

- Do not modify or open any of the components provided.
- Do not use the product if any cable is damaged or any wires are exposed.

If a power adapter is provided:

- Do not expose the power adapter to liquid or moisture.
- Unplug the power adapter before cleaning, and clean only with a dry cloth.
- Keep the power adapter away from open flames and other heat sources.
- Use only the power adapter provided with the Gear VR.

 Damaged or Broken Device

- Do not use your device if any part is broken or damaged.
- Do not attempt to repair any part of your device yourself. Repairs should only be made by an authorized servicer.

 Contagious Conditions

To avoid transferring contagious conditions (like pink eye), do not share the Gear VR with persons with contagious conditions, infections or diseases, particularly of the eyes, skin or scalp. The Gear VR should be cleaned between each use with skin-friendly antibacterial wipes (particularly the lenses) and dried with a microfiber cloth.



Skin Irritation

The Gear VR is worn next to your skin and scalp. Stop using the Gear VR if you notice swelling, itchiness, or other irritation. If symptoms persist, contact a doctor.



To avoid damage to the Gear VR

- Do not leave the Gear VR in direct sunlight. Exposure to direct sunlight can damage the Gear VR.
- Do not shine a laser or external light source through the lenses as it may damage the screen.
- Store components in their storage case when not in use to minimize unintentional damage or environmental exposure.

Safety information

To prevent injury to yourself and others or damage to your device, read the safety information about your device before using it.

Use the device for its intended purpose only.

Do not drop or cause an impact to the charger or the device.

Do not use or store your device in areas with high concentrations of dust or airborne materials.

Dust or foreign materials can cause your device to malfunction.

Do not allow the device's connector to contact conductors, such as liquid, dust, metal filings, and pencil leads.

Contact with conductors may cause a short circuit or corrosion at the connector and result in explosion, fire, or damage to the device.

Do not bite or suck the device.

Children or animals can choke on small parts.

Do not insert the device or supplied accessories into the eyes, ears, or mouth.

Doing so may cause suffocation or serious injuries.

Do not expose the device to heavy smoke or fumes.

Doing so may damage the outside of the device or cause it to malfunction.

Keep your device dry.

Humidity and liquids may damage the parts or electronic circuits in your device.

The device can be used in locations with an ambient temperature of 0 °C to 35 °C. You can store the device at an ambient temperature of -20 °C to 50 °C. Using or storing the device outside of the recommended temperature ranges may damage the device or reduce the battery's lifespan.

Do not store your device in very hot areas such as inside a car in the summertime. Doing so may cause the screen to malfunction, result in damage to the device, or cause the battery to explode.

Do not look directly at bright light while you are wearing the device without the mobile device inserted. Doing so may damage your eyesight.

Do not use the device if errors occur. Continued use of the device after errors occur may result in discomfort or personal injury.

If you are allergic to the paint or metal parts on the device, you may experience itching, eczema, or swelling of the skin. If this happens, stop using the device and consult your physician.

Do not use your device in a hospital, on an aircraft, or in any automobile that can be affected by radio frequencies. Doing so may cause malfunctions of equipment and may result in injury or damage to property.

When connecting the device to other devices via Bluetooth, avoid using your device within 15 cm of pacemakers, if possible, as your device can interfere with pacemakers.

Protect your hearing and ears when using a headset.



- Excessive exposure to loud sounds can cause hearing damage.
- Always turn the volume down before plugging the earphones into an audio source and use only the minimum volume setting necessary to hear music.
- Ensure the headset cable is not twisted around nearby objects.

Do not use the device if it is cracked or broken.

Broken glass or acrylic could cause injury to your hands and face. Take the device to a Samsung Service Centre to have it repaired.

Use manufacturer-approved batteries, chargers, accessories, and supplies.

Samsung cannot be responsible for the user's safety when using accessories or supplies that are not approved by Samsung.

Do not disassemble, modify, or repair your device.

Any changes or modifications to your device can void your manufacturer's warranty. If your device needs servicing, take your device to a Samsung Service Centre.

When cleaning your device, mind the following.

- Wipe the device and its lens with a clean soft cloth or a cotton swab.
- Do not use chemicals or detergents. Doing so may discolour or corrode the outside the device.
- Do not wash the foam cushioning. Doing so may cause the foam cushioning to deteriorate.

Handle and dispose of the device and charger with care.

- Never place the battery or device on or in heating devices, such as microwave ovens, stoves, or radiators.
- Never crush or puncture the device.

Allow only qualified personnel to service your device.

Allowing unqualified personnel to service your device may result in damage to your device and will void your manufacturer's warranty.

Correct disposal of this product



(Waste Electrical & Electronic Equipment)

(Applicable in countries with separate collection systems)



This marking on the product, accessories or literature indicates that the product and its electronic accessories (e.g. charger, headset, USB cable) should not be disposed of with other household waste.

To prevent possible harm to the environment or human health from uncontrolled waste disposal, please separate these items from other types of waste and recycle them responsibly to promote the sustainable reuse of material resources.

Household users should contact either the retailer where they purchased this product, or their local government office, for details of where and how they can take these items for environmentally safe recycling.

Business users should contact their supplier and check the terms and conditions of the purchase contract. This product and its electronic accessories should not be mixed with other commercial wastes for disposal.

This product is RoHS compliant.

For information on Samsung's environmental commitments and product-specific regulatory obligations, e.g. REACH, WEEE, Batteries, visit samsung.com/uk/aboutsamsung/samsungelectronics/corporatecitizenship/data_corner.html

Appendix

Troubleshooting

Before contacting a Samsung Service Centre, please attempt the following solutions. Some situations may not apply to your device.

If the tips below do not solve the problem, contact a Samsung Service Centre.

The Oculus Home screen does not appear when the mobile device is connected to the Gear VR

- Ensure that the mobile device is properly connected to the Gear VR.
- Ensure that the mobile device is turned on.
- Ensure that you install the Gear VR app (Oculus) for the Gear VR on the mobile device. (p. 39)
- Ensure that the mobile device's battery is fully charged.

The mobile device is hot to the touch

When using apps that require a higher amount of power than normal or when using apps on your device for an extended period, the mobile device may feel hot to the touch. When the Gear VR detects a high temperature, a message appears on the screen warning you to stop wearing the Gear VR and to wait for it to cool down. Stop using the Gear VR until the mobile device cools down, and then resume use. This is normal and should not affect the mobile device's lifespan or performance.

The image on the screen looks tilted or skewed

Remove the Gear VR and place it on a flat surface with the lenses facing forwards and the Focus adjustment wheel at the top. Wait 5–7 seconds before using it again.

The image on the screen is moving randomly

The Gear VR can be affected by magnetic interference created by items, such as computers, TVs, or electric cables. Avoid using the Gear VR in areas affected by magnetic interference.

The screen is out of focus

- Ensure that the Gear VR is correctly placed on your face.
- Rotate the Focus adjustment wheel until the screen looks clear.

The screen shifts to the left or right

Ensure that the device holder (left) is in the correct position. Reconnect your mobile device after sliding the device holder (left) to position A or B according to the size of your mobile device's screen. (p. 27)

The image on the screen is shaking

- Disconnect the mobile device from the Gear VR and then reconnect it.
- Restart the mobile device.

The controller, game controller, or Bluetooth headset do not work

- Ensure that the Bluetooth device is connected to the mobile device.
- Ensure that the mobile device and the other Bluetooth device are within the maximum Bluetooth range.
- Ensure that the battery of the Bluetooth device that you are connecting to is fully charged.
- If your controller is not functioning properly, take it and the Gear VR to a Samsung Service Centre.

Copyright

Copyright © 2017 Samsung Electronics

This manual is protected under international copyright laws.

No part of this manual may be reproduced, distributed, translated, or transmitted in any form or by any means, electronic or mechanical, including photocopying, recording, or storing in any information storage and retrieval system, without the prior written permission of Samsung Electronics.

Trademarks

- SAMSUNG and the SAMSUNG logo are registered trademarks of Samsung Electronics.
- Bluetooth® is a registered trademark of Bluetooth SIG, Inc. worldwide.
- All other trademarks and copyrights are the property of their respective owners.