



Lexmark™

B3340, B3442, M1342, MS331, MS431, MS439 Printers

User's Guide

March 2021

www.lexmark.com

Machine type:

4601

Models:

230, 280, 4a0, 480, 489

Contents

- Safety information..... 5**
 - Conventions..... 5
 - Product statements..... 5

- Learn about the printer..... 8**
 - Finding information about the printer.....8
 - Finding the printer serial number..... 9
 - Printer configuration.....10
 - Using the control panel.....11
 - Understanding the status of the indicator light..... 11
 - Selecting paper.....12

- Set up, install, and configure..... 18**
 - Selecting a location for the printer..... 18
 - Attaching cables..... 19
 - Installing optional trays..... 19
 - Loading paper and specialty media.....20
 - Installing and updating software, drivers, and firmware..... 23
 - Networking.....26
 - Printing the Menu Settings Page.....30

- Secure the printer.....31**
 - Locating the security slot.....31
 - Erasing printer memory.....31
 - Restoring factory default settings..... 31
 - Statement of Volatility..... 32

- Print..... 33**
 - Printing from a computer.....33
 - Printing from a mobile device..... 33
 - Configuring confidential jobs..... 34
 - Printing confidential and other held jobs.....35
 - Printing a font sample list.....36
 - Placing separator sheets between copies..... 36
 - Canceling a print job..... 36

Adjusting toner darkness.....37

Use printer menus..... 38

Menu map.....38
Device.....38
Print.....45
Paper.....50
Network/Ports.....52
Security.....64
Reports.....67
Troubleshooting.....68

Maintain the printer.....69

Checking the status of parts and supplies.....69
Configuring supply notifications.....69
Setting up e-mail alerts.....69
Viewing reports.....70
Ordering parts and supplies.....70
Replacing parts and supplies.....73
Cleaning printer parts.....83
Saving energy and paper.....87
Moving the printer to another location.....87
Shipping the printer.....88

Troubleshoot a problem..... 89

Print quality problems.....89
Printing problems.....90
The printer is not responding.....116
Network connection problems.....118
Issues with supplies.....120
Clearing jams.....121
Paper feed problems.....135
Contacting customer support.....138

Recycle and dispose..... 139

Recycling Lexmark products.....139
Recycling Lexmark packaging.....139

Notices.....140

Index..... 152

Safety information

Conventions

Note: A *note* identifies information that could help you.

Warning: A *warning* identifies something that could damage the product hardware or software.

CAUTION: A *caution* indicates a potentially hazardous situation that could injure you.

Different types of caution statements include:



CAUTION—POTENTIAL INJURY: Indicates a risk of injury.



CAUTION—SHOCK HAZARD: Indicates a risk of electrical shock.



CAUTION—HOT SURFACE: Indicates a risk of burn if touched.



CAUTION—TIPPING HAZARD: Indicates a crush hazard.



CAUTION—PINCH HAZARD: Indicates a risk of being caught between moving parts.

Product statements



CAUTION—POTENTIAL INJURY: To avoid the risk of fire or electrical shock, connect the power cord to an appropriately rated and properly grounded electrical outlet that is near the product and easily accessible.



CAUTION—POTENTIAL INJURY: To avoid the risk of fire or electrical shock, use only the power cord provided with this product or the manufacturer's authorized replacement.



CAUTION—POTENTIAL INJURY: Do not use this product with extension cords, multioutlet power strips, multioutlet extenders, or UPS devices. The power capacity of these types of accessories can be easily overloaded by a laser printer and may result in a risk of fire, property damage, or poor printer performance.



CAUTION—POTENTIAL INJURY: Only a Lexmark Inline Surge Protector that is properly connected between the printer and the power cord provided with the printer may be used with this product. The use of non-Lexmark surge protection devices may result in a risk of fire, property damage, or poor printer performance.











CAUTION—SHOCK HAZARD: To avoid the risk of electrical shock, do not place or use this product near water or wet locations.





CAUTION—SHOCK HAZARD: To avoid the risk of electrical shock, do not set up this product or make any electrical or cabling connections, such as the power cord, fax feature, or telephone, during a lightning storm.



CAUTION—POTENTIAL INJURY: Do not cut, twist, bind, crush, or place heavy objects on the power cord. Do not subject the power cord to abrasion or stress. Do not pinch the power cord between objects such as furniture and walls. If any of these things happen, a risk of fire or electrical shock results. Inspect the power cord regularly for signs of such problems. Remove the power cord from the electrical outlet before inspecting it.

-  **CAUTION—SHOCK HAZARD:** To avoid the risk of electrical shock, make sure that all external connections (such as Ethernet and telephone system connections) are properly installed in their marked plug-in ports.
-  **CAUTION—SHOCK HAZARD:** To avoid the risk of electrical shock, if you are accessing the controller board or installing optional hardware or memory devices sometime after setting up the printer, then turn the printer off, and unplug the power cord from the electrical outlet before continuing. If you have any other devices attached to the printer, then turn them off as well, and unplug any cables going into the printer.
-  **CAUTION—SHOCK HAZARD:** To avoid the risk of electrical shock when cleaning the exterior of the printer, unplug the power cord from the electrical outlet and disconnect all cables from the printer before proceeding.
-  **CAUTION—POTENTIAL INJURY:** If the printer weight is greater than 20 kg (44 lb), then it may require two or more people to lift it safely.
-  **CAUTION—POTENTIAL INJURY:** When moving the printer, follow these guidelines to avoid personal injury or printer damage:
- Make sure that all doors and trays are closed.
 - Turn off the printer, and then unplug the power cord from the electrical outlet.
 - Disconnect all cords and cables from the printer.
 - If the printer has separate floor-standing optional trays or output options attached to it, then disconnect them before moving the printer.
 - If the printer has a caster base, then carefully roll it to the new location. Use caution when passing over thresholds and breaks in flooring.
 - If the printer does not have a caster base but is configured with optional trays or output options, then remove the output options and lift the printer off the trays. Do not try to lift the printer and any options at the same time.
 - Always use the handholds on the printer to lift it.
 - Any cart used to move the printer must have a surface able to support the full footprint of the printer.
 - Any cart used to move the hardware options must have a surface able to support the dimensions of the options.
 - Keep the printer in an upright position.
 - Avoid severe jarring movements.
 - Make sure that your fingers are not under the printer when you set it down.
 - Make sure that there is adequate clearance around the printer.
-  **CAUTION—TIPPING HAZARD:** Installing one or more options on your printer or MFP may require a caster base, furniture, or other feature to prevent instability causing possible injury. For more information on supported configurations, see www.lexmark.com/multifunctionprinters.
-  **CAUTION—TIPPING HAZARD:** To reduce the risk of equipment instability, load each tray separately. Keep all other trays closed until needed.
-  **CAUTION—HOT SURFACE:** The inside of the printer might be hot. To reduce the risk of injury from a hot component, allow the surface to cool before touching it.
-  **CAUTION—PINCH HAZARD:** To avoid the risk of a pinch injury, use caution in areas marked with this label. Pinch injuries may occur around moving parts, such as gears, doors, trays, and covers.

 **CAUTION—POTENTIAL INJURY:** This product uses a laser. Use of controls or adjustments or performance of procedures other than those specified in the *User's Guide* may result in hazardous radiation exposure.

 **CAUTION—POTENTIAL INJURY:** The lithium battery in this product is not intended to be replaced. There is a danger of explosion if a lithium battery is incorrectly replaced. Do not recharge, disassemble, or incinerate a lithium battery. Discard used lithium batteries according to the manufacturer's instructions and local regulations.

This product is designed, tested, and approved to meet strict global safety standards with the use of specific manufacturer's components. The safety features of some parts may not always be obvious. The manufacturer is not responsible for the use of other replacement parts.

Refer service or repairs, other than those described in the user documentation, to a service representative.

This product uses a printing process that heats the print media, and the heat may cause the media to release emissions. You must understand the section in your operating instructions that discusses the guidelines for selecting print media to avoid the possibility of harmful emissions.

This product may produce small amounts of ozone during normal operation, and may be equipped with a filter designed to limit ozone concentrations to levels well below the recommended exposure limits. To avoid high ozone concentration levels during extensive usage, install this product in a well-ventilated area and replace the ozone and exhaust filters if instructed to do so in the product maintenance instructions. If there are no references to filters in the product maintenance instructions, then there are no filters requiring replacement for this product.

SAVE THESE INSTRUCTIONS.

Learn about the printer

Finding information about the printer

What are you looking for?	Find it here
Initial setup instructions	See the setup documentation that came with the printer.
<ul style="list-style-type: none"> • Printer software • Print or fax driver • Printer firmware • Utility 	Go to www.lexmark.com/downloads , search for your printer model, and then in the Type menu, select the driver, firmware, or utility that you need.
<ul style="list-style-type: none"> • Selecting and storing paper and specialty media • Loading paper • Configuring printer settings • Viewing and printing documents and photos • Setting up and using the printer software • Configuring the printer on a network • Caring for and maintaining the printer • Troubleshooting and solving problems 	<p><i>Information Center</i>—Go to https://infoserve.lexmark.com.</p> <p><i>How-to videos</i>—Go to https://infoserve.lexmark.com/idv/.</p>
Help information for using the printer software	<p>Help for Microsoft Windows or Macintosh operating systems—Open a printer software program or application, and then click Help.</p> <p>Click  to view context-sensitive information.</p> <p>Notes:</p> <ul style="list-style-type: none"> • Help is automatically installed with the printer software. • Depending on the operating system, the printer software is either in the printer program folder or on the desktop.
<ul style="list-style-type: none"> • Documentation • Live chat support • E-mail support • Voice support 	<p>Go to http://support.lexmark.com.</p> <p>Note: Select your country or region, and then select your product to view the appropriate support site.</p> <p>Support contact information for your country or region can be found on the website or on the printed warranty that came with the printer.</p> <p>Have the following information ready when you contact customer support:</p> <ul style="list-style-type: none"> • Place and date of purchase • Machine type and serial number <p>For more information, see “Finding the printer serial number” on page 9.</p>

What are you looking for?	Find it here
<ul style="list-style-type: none">• Safety information• Regulatory information• Warranty information• Environmental information	<p>Warranty information varies by country or region:</p> <ul style="list-style-type: none">• In the U.S.—See the Statement of Limited Warranty included with the printer, or go to http://support.lexmark.com.• In other countries and regions—See the printed warranty that came with the printer. <p><i>Product Information Guide</i>—See the documentation that came with the printer or go to http://support.lexmark.com.</p>

Finding the printer serial number

- 1 Open the front door.

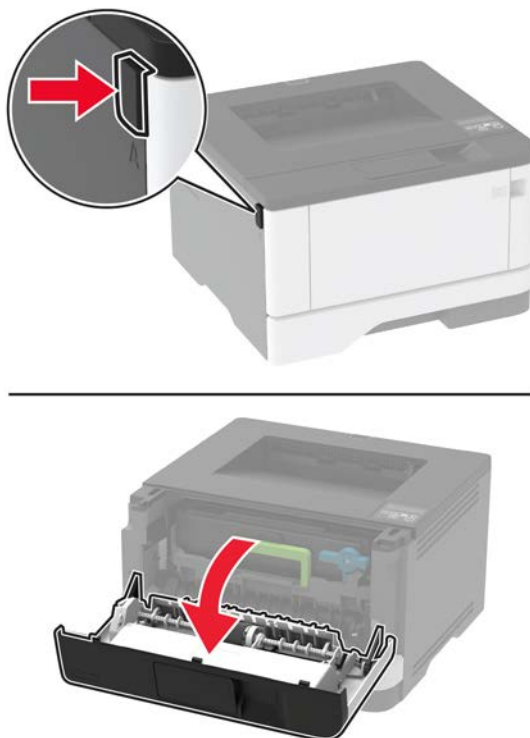

2 Locate the printer serial number behind the front door.

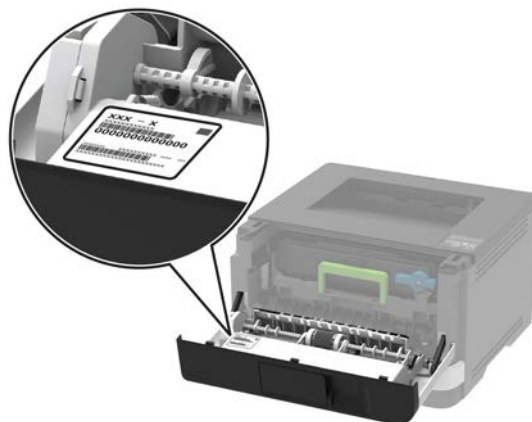

Printer configuration



1	Control panel
2	Multipurpose feeder
3	Standard 250-sheet tray
4	Optional 550-sheet tray
5	Standard bin

Using the control panel

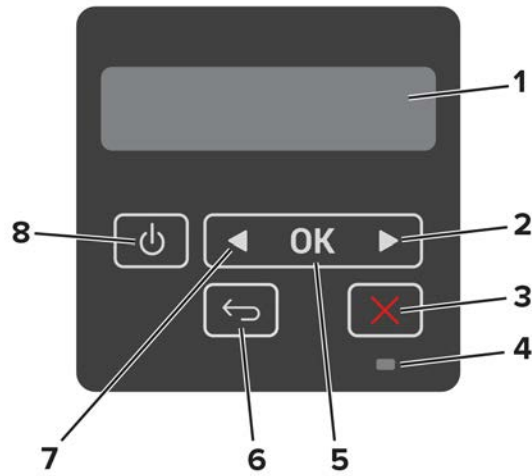

	Control panel part	Function
1	Display	<ul style="list-style-type: none"> View printer messages and supply status. Set up and operate the printer.
2	Right arrow button	<ul style="list-style-type: none"> Scroll through menus or move between screens and menu options. Increase the numeric value of a setting.
3	Stop or Cancel button	Stop the current job.
4	Indicator light	Check the status of the printer.
5	Select button	<ul style="list-style-type: none"> Select a menu option. Save the changes in a setting.
6	Back button	Return to the previous screen.
7	Left arrow button	<ul style="list-style-type: none"> Scroll through menus or move between screens and menu options. Decrease the numeric value of a setting.
8	Power button	Turn on or turn off the printer. Note: To turn off the printer, press and hold the power button for five seconds.

Understanding the status of the indicator light

Indicator light	Printer status
Off	The printer is off or in Hibernate mode.
Blue	The printer is ready or processing data.
Blinking red	The printer requires user intervention.
Solid amber	The printer is in Sleep mode.

Selecting paper

Paper guidelines

Use the appropriate paper to prevent jams and help ensure trouble-free printing.

- Always use new, undamaged paper.
- Before loading paper, know the recommended printable side of the paper. This information is usually indicated on the paper package.
- Do not use paper that has been cut or trimmed by hand.
- Do not mix paper sizes, types, or weights in the same tray; mixing results in jams.
- Do not use coated papers unless they are specifically designed for electrophotographic printing.

Paper characteristics

The following paper characteristics affect print quality and reliability. Consider these factors before printing on them.

Weight

The standard tray can feed paper weights from 60 to 120 g/m² (16 to 32 lb) grain long paper. Paper lighter than 60 g/m² (16 lb) may not be stiff enough to feed properly, and may cause jams.

Curl

Curl is the tendency for paper to curl at its edges. Excessive curl can cause paper feeding problems. Curl can occur after the paper passes through the printer, where it is exposed to high temperatures. Storing paper unwrapped in hot, humid, cold, or dry conditions can contribute to paper curling before printing and can cause feeding problems.

Smoothness

Paper smoothness directly affects print quality. If paper is too rough, toner cannot fuse to it properly. If paper is too smooth, it can cause paper feeding or print quality issues. We recommend the use of paper with 50 Sheffield points.

Moisture content

The amount of moisture in paper affects both print quality and the printer ability to feed the paper correctly. Leave paper in its original wrapper until you use it. Exposure of paper to moisture changes can degrade its performance.

Store paper in its original wrapper in the same environment as the printer for 24 to 48 hours before printing. Extend the time several days if the storage or transportation environment is very different from the printer environment. Thick paper may also require a longer conditioning period.

Grain direction

Grain refers to the alignment of the paper fibers in a sheet of paper. Grain is either *grain long*, running the length of the paper, or *grain short*, running the width of the paper.

For 60–120 g/m² (16–32-lb) paper, grain long paper is recommended.

Fiber content

Most high-quality xerographic paper is made from 100 percent chemically treated pulped wood. This content provides the paper with a high degree of stability, resulting in fewer paper feeding problems and better print quality. Paper containing fibers such as cotton can negatively affect paper handling.

Unacceptable paper

The following paper types are not recommended for use with the printer:

- Chemically treated papers used to make copies without carbon paper, also known as carbonless papers, carbonless copy paper (CCP), or no carbon required (NCR) paper
- Preprinted papers with chemicals that may contaminate the printer
- Preprinted papers that can be affected by the temperature in the printer fuser
- Preprinted papers that require a registration (the precise print location on the page) greater than ± 2.3 mm (± 0.9 in.), such as optical character recognition (OCR) forms

In some cases, registration can be adjusted with a software application to successfully print on these forms.

- Coated papers (erasable bond), synthetic papers, thermal papers
- Rough-edged, rough or heavily textured surface papers, or curled papers
- Recycled papers that fail EN12281:2002 (European)
- Paper weighing less than 60 g/m^2 (16 lb)
- Multiple-part forms or documents

Selecting preprinted forms and letterhead

- Use grain long paper.
- Use only forms and letterhead printed using an offset lithographic or engraved printing process.
- Avoid paper with rough or heavily textured surfaces.
- Use inks that are not affected by the resin in toner. Inks that are oxidation-set or oil-based generally meet these requirements; latex inks might not.
- Print samples on preprinted forms and letterheads considered for use before buying large quantities. This action determines whether the ink in the preprinted form or letterhead affects print quality.
- When in doubt, contact your paper supplier.
- When printing on letterhead, load the paper in the proper orientation for your printer. For more information, see the *Paper and Specialty Media Guide*.

Storing paper

Use these paper storage guidelines to help avoid jams and uneven print quality:

- Store paper in its original wrapper in the same environment as the printer for 24 to 48 hours before printing.
- Extend the time several days if the storage or transportation environment is very different from the printer environment. Thick paper may also require a longer conditioning period.
- For best results, store paper where the temperature is 21°C (70°F) and the relative humidity is 40 percent.
- Most label manufacturers recommend printing in a temperature range of $18\text{--}24^\circ\text{C}$ ($65\text{--}75^\circ\text{F}$) with relative humidity between 40 and 60 percent.
- Store paper in cartons, on a pallet or shelf, rather than on the floor.

- Store individual packages on a flat surface.
- Do not store anything on top of individual paper packages.
- Take paper out of the carton or wrapper only when you are ready to load it in the printer. The carton and wrapper help keep the paper clean, dry, and flat.

Supported paper sizes

Paper size	Standard 250-sheet tray	Optional 550-sheet tray	Multipurpose feeder	Two-sided printing
A4 210 x 297 mm (8.27 x 11.7 in.)	✓	✓	✓	✓
A5 Portrait (SEF) 148 x 210 mm (5.83 x 8.27 in.)	✓	✓	✓	X
A5 Landscape (LEF)¹ 210 x 148 mm (8.27 x 5.83 in.)	✓	✓	✓	X
A6 105 x 148 mm (4.13 x 5.83 in.)	✓	✓	✓	X
JIS B5 182 x 257 mm (7.17 x 10.1 in.)	✓	✓	✓	X
Oficio (Mexico) 215.9 x 340.4 mm (8.5 x 13.4 in.)	✓	✓	✓	✓
Hagaki 100 x 148 mm (3.94 x 5.83 in.)	✓	X	✓	X
Statement 139.7 x 215.9 mm (5.5 x 8.5 in.)	✓	✓	✓	X
Executive 184.2 x 266.7 mm (7.25 x 10.5 in.)	✓	✓	✓	X

¹ The default support is long-edge feed.

² Paper must at least be 210 mm (8.27in.) wide and 279.4 mm (11 in.) long for two-sided printing.

³ When Universal is selected, the page is formatted for 215.90 x 355.60 mm (8.5 x 14 in.) unless specified by the application.

Paper size	Standard 250-sheet tray	Optional 550-sheet tray	Multipurpose feeder	Two-sided printing
Letter 215.9 x 279.4 mm (8.5 x 11 in.)	✓	✓	✓	✓
Legal 215.9 x 355.6 mm (8.5 x 14 in.)	✓	✓	✓	✓
Folio 215.9 x 330.2 mm (8.5 x 13 in.)	✓	✓	✓	✓
Universal³ 99 x 148 mm to 215.9 x 359.92 mm (3.9 x 5.83 in. to 8.5 x 14.17 in.)	✓	✓	✓	✓ ²
7 3/4 Envelope 98.4 x 190.5 mm (3.875 x 7.5 in.)	X	X	✓	X
9 Envelope 98.4 x 225.4 mm (3.875 x 8.9 in.)	X	X	✓	X
10 Envelope 104.8 x 241.3 mm (4.12 x 9.5 in.)	X	X	✓	X
DL Envelope 110 x 220 mm (4.33 x 8.66 in.)	X	X	✓	X
C5 Envelope 162 x 229 mm (6.38 x 9.01 in.)	X	X	✓	X
B5 Envelope 176 x 250 mm (6.93 x 9.84 in.)	X	X	✓	X

¹ The default support is long-edge feed.

² Paper must at least be 210 mm (8.27in.) wide and 279.4 mm (11 in.) long for two-sided printing.

³ When Universal is selected, the page is formatted for 215.90 x 355.60 mm (8.5 x 14 in.) unless specified by the application.

Paper size	Standard 250-sheet tray	Optional 550-sheet tray	Multipurpose feeder	Two-sided printing
Other Envelope 98.4 x 162 mm to 176 x 250 mm (3.87 x 6.38 in. to 6.93 x 9.84 in.)	X	X	✓	X
¹ The default support is long-edge feed. ² Paper must at least be 210 mm (8.27in.) wide and 279.4 mm (11 in.) long for two-sided printing. ³ When Universal is selected, the page is formatted for 215.90 x 355.60 mm (8.5 x 14 in.) unless specified by the application.				

Supported paper types

Paper type	Standard 250-sheet tray	Optional 550-sheet tray	Multipurpose feeder	Two-sided printing
Plain paper	✓	✓	✓	✓
Card stock	X	X	✓	X
Recycled	✓	✓	✓	✓
Paper labels*	✓	✓	✓	X
Bond	✓	✓	✓	✓
Letterhead	✓	✓	✓	✓
Preprinted	✓	✓	✓	✓
Colored Paper	✓	✓	✓	✓
Light Paper	✓	✓	✓	✓
Heavy Paper	✓	✓	✓	✓
Rough/Cotton	✓	✓	✓	✓
Envelope	X	X	✓	X
Rough envelope	X	X	✓	X
* One-sided paper labels are supported for occasional use of less than 20 pages per month. Vinyl, pharmacy, or two-sided labels are not supported.				

Supported paper weights

	Standard 250-sheet tray	Optional 550-sheet tray	Multipurpose feeder	Two-sided printing
Paper weight	60–120 g/m ² (16–32 lb)	60–120 g/m ² (16–32 lb)	60–217 g/m ² (16–58 lb)	60–90 g/m ² (16–24 lb)

Set up, install, and configure

Selecting a location for the printer

- Leave enough room to open trays, covers, and doors and to install hardware options.
- Set up the printer near an electrical outlet.

⚠ CAUTION—POTENTIAL INJURY: To avoid the risk of fire or electrical shock, connect the power cord to an appropriately rated and properly grounded electrical outlet that is near the product and easily accessible.

⚡ CAUTION—SHOCK HAZARD: To avoid the risk of electrical shock, do not place or use this product near water or wet locations.

- Make sure that airflow in the room meets the latest revision of the ASHRAE 62 standard or the CEN Technical Committee 156 standard.
- Provide a flat, sturdy, and stable surface.
- Keep the printer:
 - Clean, dry, and free of dust
 - Away from stray staples and paper clips
 - Away from the direct airflow of air conditioners, heaters, or ventilators
 - Free from direct sunlight and humidity extremes
- Observe the recommended temperatures and avoid fluctuations.

Ambient temperature	10 to 32.2°C (50 to 90°F)
Storage temperature	-40 to 40°C (-40 to 104°F)

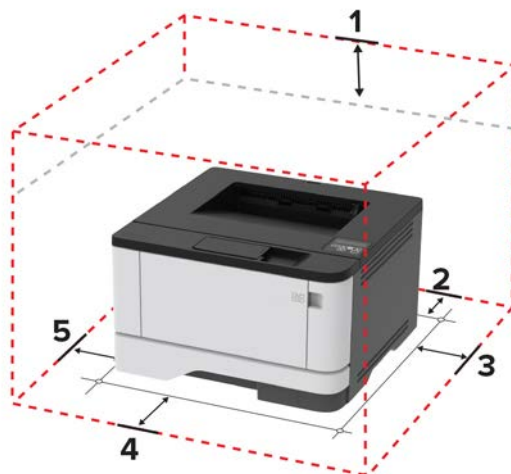

- Allow the following recommended amount of space around the printer for proper ventilation:



1	Top	305 mm (12 in.)
2	Rear	100 mm (3.94 in.)
3	Right side	76.2 mm (3 in.)

4	Front	305 mm (12 in.) Note: The minimum space needed in front of the printer is 76 mm (3 in.).
5	Left side	110 mm (4.33 in.)

Attaching cables

-  **CAUTION—SHOCK HAZARD:** To avoid the risk of electrical shock, do not set up this product or make any electrical or cabling connections, such as the power cord, fax feature, or telephone, during a lightning storm.
-  **CAUTION—POTENTIAL INJURY:** To avoid the risk of fire or electrical shock, connect the power cord to an appropriately rated and properly grounded electrical outlet that is near the product and easily accessible.
-  **CAUTION—POTENTIAL INJURY:** To avoid the risk of fire or electrical shock, use only the power cord provided with this product or the manufacturer's authorized replacement.

Warning—Potential Damage: To avoid loss of data or printer malfunction, do not touch the USB cable, any wireless network adapter, or the printer in the areas shown while actively printing.



	Printer port	Function
1	USB printer port	Connect the printer to a computer.
2	Ethernet port	Connect the printer to a network.
3	Power cord socket	Connect the printer to an electrical outlet.

Installing optional trays

 **CAUTION—SHOCK HAZARD:** To avoid the risk of electrical shock, if you are accessing the controller board or installing optional hardware or memory devices sometime after setting up the printer, then turn the printer off, and unplug the power cord from the electrical outlet before continuing. If you have any other devices attached to the printer, then turn them off as well, and unplug any cables going into the printer.

- 1** Turn off the printer.
- 2** Unplug the power cord from the electrical outlet, and then from the printer.
- 3** Unpack the optional tray, and then remove all packing material.
- 4** Align the printer with the optional tray, and then lower the printer into place.

⚠ CAUTION—POTENTIAL INJURY: If the printer weight is greater than 20 kg (44 lb), then it may require two or more people to lift it safely.



5 Connect the power cord to the printer, and then to the electrical outlet.

⚠ CAUTION—POTENTIAL INJURY: To avoid the risk of fire or electrical shock, connect the power cord to an appropriately rated and properly grounded electrical outlet that is near the product and easily accessible.

6 Turn on the printer.

Add the tray in the print driver to make it available for print jobs. For more information, see [“Adding available options in the print driver” on page 26](#).

Loading paper and specialty media

Setting the paper size and type

1 From the control panel, navigate to:

Settings > **OK** > **Paper** > **OK** > **Tray Configuration** > **OK** > **Paper Size/Type** > **OK** > select a paper source

2 Set the paper size and type.

Configuring Universal paper settings

1 From the control panel, navigate to:

Settings > **OK** > **Paper** > **OK** > **Media Configuration** > **OK** > **Universal Setup** > **OK**

2 Configure the settings.

Loading trays

1 Remove the tray.

Note: To avoid paper jams, do not remove the tray while the printer is busy.



2 Adjust the guides to match the size of the paper that you are loading.

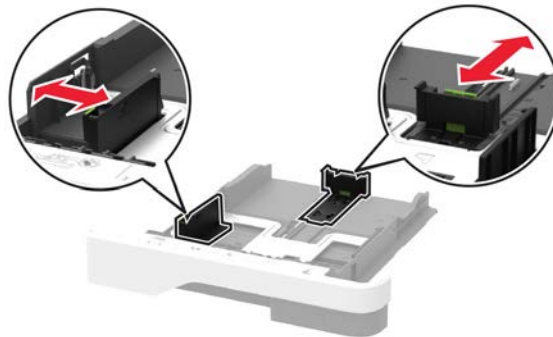

3 Flex, fan, and align the paper edges before loading.

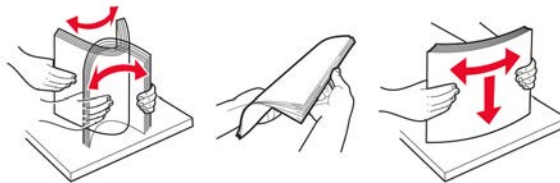

4 Load the paper stack with the printable side facedown, and then make sure that the guides fit snugly against the paper.

Notes:

- Load letterhead facedown with the header toward the front of the tray for one-sided printing.
- Load letterhead faceup with the header toward the back of the tray for two-sided printing.
- Do not slide paper into the tray.
- To avoid paper jams, make sure that the stack height is below the maximum paper fill indicator.



5 Insert the tray.

If necessary, set the paper size and paper type from the control panel to match the paper loaded.

Loading the multipurpose feeder

1 Open the multipurpose feeder.

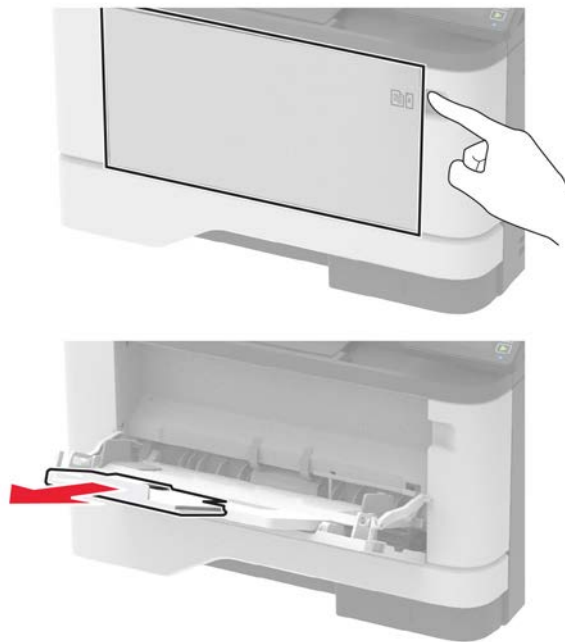

2 Flex, fan, and align the paper edges before loading.

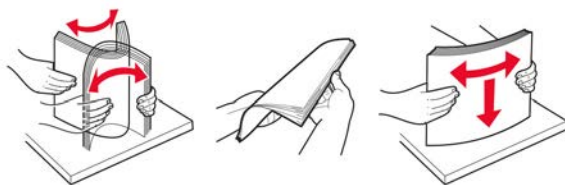

3 Load paper with the printable side faceup.

Notes:

- Load letterhead faceup with the header toward the rear of the printer for one-sided printing.
- Load letterhead facedown with the header toward the front of the printer for two-sided printing.
- Load envelopes with the flap facedown on the left side.

Warning—Potential Damage: Do not use envelopes with stamps, clasps, snaps, windows, coated linings, or self-stick adhesives.

- 4 Adjust the guide to match the size of the paper that you are loading.

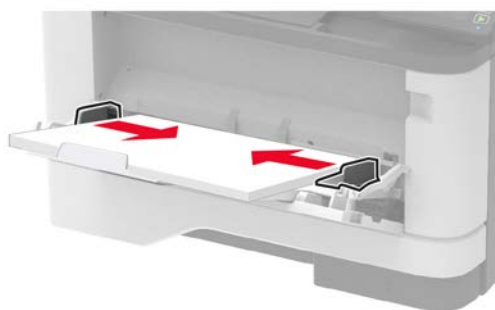

- 5 From the control panel, set the paper size and paper type to match the paper loaded.

Linking trays

- 1 From the control panel, navigate to:

Settings > **OK** > **Paper** > **OK** > **Tray Configuration** > **OK** > **Paper Size/Type** > **OK**

- 2 Set the same paper size and paper type for the trays that you are linking.

- 3 From the control panel, navigate to:

Settings > **OK** > **Device** > **OK** > **Maintenance** > **OK** > **Config Menu** > **OK** > **Tray Configuration** > **OK**

- 4 Set Tray Linking to **Automatic**.

To unlink trays, make sure that no trays have the same paper size and paper type settings.

Warning—Potential Damage: The temperature of the fuser varies according to the specified paper type. To avoid printing issues, match the paper type setting in the printer with the paper loaded in the tray.

Installing and updating software, drivers, and firmware

Installing the printer software

Notes:

- The print driver is included in the software installer package.

- For Macintosh computers with macOS version 10.7 or later, you do not need to install the driver to print on an AirPrint-certified printer. If you want custom printing features, then download the print driver.

1 Obtain a copy of the software installer package.

- From the software CD that came with your printer.
- Go to www.lexmark.com/downloads.

2 Run the installer, and then follow the instructions on the computer screen.

Adding printers to a computer

Before you begin, do one of the following:

- Connect the printer and the computer to the same network. For more information on connecting the printer to a network, see [“Connecting the printer to a Wi-Fi network” on page 26](#).
- Connect the computer to the printer. For more information, see [“Connecting a computer to the printer” on page 29](#).
- Connect the printer to the computer using a USB cable. For more information, see [“Attaching cables” on page 19](#).

Note: The USB cable is sold separately.

For Windows users

1 From a computer, install the print driver.

Note: For more information, see [“Installing the printer software” on page 23](#).

2 Open **Printers & scanners**, and then click **Add a printer or scanner**.

3 Depending on your printer connection, do one of the following:

- Select a printer from the list, and then click **Add device**.
- Click **Show Wi-Fi Direct printers**, select a printer, and then click **Add device**.
- Click **The printer that I want isn't listed**, and then from the Add Printer window, do the following:
 - a** Select **Add a printer using a TCP/IP address or hostname**, and then click **Next**.
 - b** In the “Hostname or IP address” field, type the printer IP address, and then click **Next**.

Notes:

- View the printer IP address on the printer home screen. The IP address appears as four sets of numbers separated by periods, such as 123.123.123.123.
- If you are using a proxy server, then temporarily disable it to load the web page correctly.

c Select a print driver, and then click **Next**.

d Select **Use the print driver that is currently installed (recommended)**, and then click **Next**.

e Type a printer name, and then click **Next**.

f Select a printer sharing option, and then click **Next**.

g Click **Finish**.

For Macintosh users

1 From a computer, open **Printers & Scanners**.

2 Click **+**, and then select a printer.

3 From the Use menu, select a print driver.

Notes:

- To use the Macintosh print driver, select either **AirPrint** or **Secure AirPrint**.
- If you want custom printing features, then select the Lexmark print driver. To install the driver, see [“Installing the printer software” on page 23](#).

4 Add the printer.

Updating firmware

Some applications require a minimum device firmware level to operate correctly.

For more information on updating the device firmware, contact your Lexmark representative.

1 Open a web browser, and then type the printer IP address in the address field.

Notes:

- View the printer IP address on the printer home screen. The IP address appears as four sets of numbers separated by periods, such as 123.123.123.123.
- If you are using a proxy server, then temporarily disable it to load the web page correctly.

2 Click **Settings > Device > Update Firmware**.

3 Do either of the following:

- Click **Check for updates > I agree, start update**.
- Upload the flash file.

Note: To get the latest firmware, go to www.lexmark.com/downloads, and then search for your printer model.

a Browse to the flash file.

Note: Make sure that you have extracted the firmware zip file.

b Click **Upload > Start**.

Exporting or importing a configuration file

You can export the configuration settings of your printer into a text file, and then import the file to apply the settings to other printers.

1 Open a web browser, and then type the printer IP address in the address field.

Notes:

- View the printer IP address on the printer home screen. The IP address appears as four sets of numbers separated by periods, such as 123.123.123.123.
- If you are using a proxy server, then temporarily disable it to load the web page correctly.

2 From the Embedded Web Server, click **Export Configuration** or **Import Configuration**.

3 Follow the instructions on the screen.

- 4 If the printer supports applications, then do the following:
 - a Click **Apps** > select the application > **Configure**.
 - b Click **Export** or **Import**.

Adding available options in the print driver

For Windows users

- 1 Open the printers folder.
- 2 Select the printer you want to update, and then do either of the following:
 - For Windows 7 or later, select **Printer properties**.
 - For earlier versions, select **Properties**.
- 3 Navigate to the Configuration tab, and then select **Update Now - Ask Printer**.
- 4 Apply the changes.

For Macintosh users

- 1 From System Preferences in the Apple menu, navigate to your printer, and then select **Options & Supplies**.
- 2 Navigate to the list of hardware options, and then add any installed options.
- 3 Apply the changes.

Networking

Connecting the printer to a Wi-Fi network

Note: This feature is available only in some printer models.

Before you begin, make sure that:

- Active Adapter is set to Auto. From the control panel, navigate to **Settings** > **OK** > **Network/Ports** > **OK** > **Network Overview** > **OK** > **Active Adapter** > **OK** > **Auto** > **OK**.
- The Ethernet cable is not connected to the printer.

Using the control panel

- 1 From the control panel, navigate to:
Settings > **OK** > **Network/Ports** > **OK** > **Wireless** > **OK** > **Setup On Printer Panel** > **OK** > **Choose Network** > **OK**
- 2 Select a Wi-Fi network, and then type the network password.

Note: For Wi-Fi-network-ready printer models, a prompt to set up the Wi-Fi network appears during initial setup.

Using Lexmark Mobile Assistant

- 1 Depending on your mobile device, download the Lexmark Mobile Assistant app from either Google Play™ or App Store.
- 2 From the printer control panel, navigate to:
Settings > **OK** > **Network/Ports** > **OK** > **Wireless** > **OK** > **Setup Using Mobile App** > **OK** > **Printer ID** > **OK**
- 3 From your mobile device, launch the app, and then accept the Terms of Use.
Note: If necessary, grant permissions.
- 4 Tap **Connect to Printer** > **Go to Wi-Fi Settings**.
- 5 Connect your mobile device to the printer wireless network.
- 6 Return to the app, and then tap **Setup Wi-Fi Connection**.
- 7 Select a Wi-Fi network, and then type the network password.
- 8 Tap **Done**.

Connecting the printer to a wireless network using Wi-Fi Protected Setup (WPS)

Note: This feature is available only in some printer models.

Before you begin, make sure that:

- The access point (wireless router) is WPS-certified or WPS-compatible. For more information, see the documentation that came with your access point.
- A wireless network adapter is installed in your printer. For more information, see the instructions that came with the adapter.
- Make sure that Active Adapter is set to Auto. From the control panel, navigate to:

Settings > **OK** > **Network/Ports** > **OK** > **Network Overview** > **OK** > **Active Adapter** > **OK** > **Auto** > **OK**

Using the Push Button method

- 1 From the control panel, navigate to:
Settings > **OK** > **Network/Ports** > **OK** > **Wireless** > **OK** > **Wi-Fi Protected Setup** > **OK** > **Start Push Button Method** > **OK**
- 2 Follow the instructions on the display.

Using the personal identification number (PIN) method

- 1 From the control panel, navigate to:
Settings > **OK** > **Network/Ports** > **OK** > **Wireless** > **OK** > **Wi-Fi Protected Setup** > **OK** > **Start PIN Method** > **OK**
- 2 Copy the eight-digit WPS PIN.
- 3 Open a web browser, and then type the IP address of your access point in the address field.

Notes:

- To know the IP address, see the documentation that came with your access point.
 - If you are using a proxy server, then temporarily disable it to load the web page correctly.
- 4 Access the WPS settings. For more information, see the documentation that came with your access point.
 - 5 Enter the eight-digit PIN, and then save the changes.

Configuring Wi-Fi Direct

Note: This feature is available only in some printer models.

Wi-Fi Direct® is a Wi-Fi-based peer-to-peer technology that allows wireless devices to connect directly to a Wi-Fi Direct-enabled printer without using an access point (wireless router).

- 1 From the control panel, navigate to:

Settings > **OK** > **Network/Ports** > **OK** > **Wi-Fi Direct** > **OK**

- 2 Configure the settings.

- **Enable Wi-Fi Direct**—Enables the printer to broadcast its own Wi-Fi Direct network.
- **Wi-Fi Direct Name**—Assigns a name for the Wi-Fi Direct network.
- **Wi-Fi Direct Password**—Assigns the password for negotiating the wireless security when using the peer-to-peer connection.
- **Show Password on Setup Page**—Shows the password on the Network Setup Page.
- **Auto-Accept Push Button Requests**—Lets the printer accept connection requests automatically.

Note: Accepting push-button requests automatically is not secured.

Connecting a mobile device to the printer

Before connecting your mobile device, make sure that Wi-Fi Direct has been configured. For more information, see [“Configuring Wi-Fi Direct” on page 28](#).

Connecting using Wi-Fi Direct

Note: These instructions apply only to Android mobile devices.

- 1 From the mobile device, go to the settings menu.
- 2 Enable **Wi-Fi**, and then tap **Wi-Fi Direct**.
- 3 Select the printer Wi-Fi Direct name.
- 4 Confirm the connection on the printer control panel.

Connecting using Wi-Fi

- 1 From the mobile device, go to the settings menu.
- 2 Tap **Wi-Fi**, and then select the printer Wi-Fi Direct name.

Note: The string DIRECT-xy (where x and y are two random characters) is added before the Wi-Fi Direct name.

- 3 Enter the Wi-Fi Direct password.

Connecting a computer to the printer

Before connecting your computer, make sure that Wi-Fi Direct has been configured. For more information, see [“Configuring Wi-Fi Direct” on page 28](#).

For Windows users

- 1 Open **Printers & scanners**, and then click **Add a printer or scanner**.
- 2 Click **Show Wi-Fi Direct printers**, and then select the printer Wi-Fi Direct name.
- 3 From the printer display, take note of the eight-digit PIN of the printer.
- 4 Enter the PIN on the computer.

Note: If the print driver is not already installed, then Windows downloads the appropriate driver.

For Macintosh users

- 1 Click the wireless icon, and then select the printer Wi-Fi Direct name.

Note: The string DIRECT-xy (where x and y are two random characters) is added before the Wi-Fi Direct name.

- 2 Type the Wi-Fi Direct password.

Note: Switch your computer back to its previous network after disconnecting from the Wi-Fi Direct network.

Deactivating the Wi-Fi network

Note: This feature is available only in some printer models.

- 1 From the printer control panel, navigate to:

Settings > **OK** > **Network/Ports** > **OK** > **Network Overview** > **OK** > **Active Adapter** > **OK** > **Standard Network** > **OK**

- 2 Follow the instructions on the display.

Checking the printer connectivity

- 1 From the control panel, navigate to:

Settings > **OK** > **Reports** > **OK** > **Network** > **OK** > **Network Setup Page** > **OK**

- 2 Check the first section of the page and confirm that the status is connected.

If the status is not connected, then the LAN drop may be inactive, or the network cable may be unplugged or malfunctioning. Contact your administrator for assistance.

Printing the Menu Settings Page

- 1 From the control panel, navigate to:
Settings > **OK** > **Reports** > **OK**
- 2 Select **Menu Settings Page**, and then press **OK**.

Secure the printer

Locating the security slot

The printer is equipped with a security lock feature. Attach a security lock compatible with most laptop computers in the location shown to secure the printer in place.



Erasing printer memory

To erase volatile memory or buffered data, turn off the printer.

To erase non-volatile memory or individual settings, device and network settings, security settings, and embedded solutions, do the following:

- 1 From the control panel, navigate to:

Settings > **OK** > **Device** > **OK** > **Maintenance** > **OK** > **Out of Service Erase** > **OK** > **Sanitize all information on nonvolatile memory** > **OK** > **Yes** > **OK**

- 2 Select either **Start initial setup** or **Leave printer offline**, and then press **OK**.

Restoring factory default settings

- 1 From the control panel, navigate to:

Settings > **OK** > **Device** > **OK** > **Restore Factory Defaults** > **OK** > **Restore all settings** > **OK**

- 2 Select **Yes**, and then press **OK**.

Statement of Volatility

Your printer contains various types of memory that can store device and network settings, and user data.

Type of memory	Description
Volatile memory	Your printer uses standard <i>random access memory</i> (RAM) to temporarily buffer user data during simple print jobs.
Non-volatile memory	Your printer may use two forms of non-volatile memory: EEPROM and NAND (flash memory). Both types are used to store operating system, device settings, and network information.

Erase the content of any installed printer memory in the following circumstances:

- The printer is being decommissioned.
- The printer is being moved to a different department or location.
- The printer is being serviced by someone from outside your organization.
- The printer is being removed from your premises for service.
- The printer is being sold to another organization.

Print

Printing from a computer

Note: For labels, card stock, and envelopes, set the paper size and type in the printer before printing the document.

- 1 From the document that you are trying to print, open the Print dialog.
- 2 If necessary, adjust the settings.
- 3 Print the document.

Printing from a mobile device

Printing from a mobile device using Lexmark Mobile Print

Lexmark™ Mobile Print allows you to send documents and images directly to a supported Lexmark printer.

Note: This feature is available only in some printer models.



- 1 Open the document, and then send or share the document to Lexmark Mobile Print.
Note: Some third-party applications may not support the send or share feature. For more information, see the documentation that came with the application.
- 2 Select a printer.
- 3 Print the document.

Printing from a mobile device using Mopria Print Service

Note: This feature is available only in some printer models.

Mopria® Print Service is a mobile printing solution for mobile devices running on Android™ version 5.0 or later. It allows you to print directly to any Mopria-certified printer.

Note: Make sure that you download the Mopria Print Service application from the Google Play store and enable it in the mobile device.

- 1 From your Android mobile device, launch a compatible application or select a document from your file manager.
- 2 Tap  > **Print**.
- 3 Select a printer, and then adjust the settings, if necessary.
- 4 Tap .

Printing from a mobile device using AirPrint

The AirPrint software feature is a mobile printing solution that allows you to print directly from Apple devices to an AirPrint-certified printer.

Notes:

- Make sure that the Apple device and the printer are connected to the same network. If the network has multiple wireless hubs, then make sure that both devices are connected to the same subnet.
- This application is supported only in some Apple devices.

1 From your mobile device, select a document from your file manager or launch a compatible application.

2 Tap  > **Print**.

3 Select a printer, and then adjust the settings, if necessary.

4 Print the document.

Printing from a mobile device using Wi-Fi Direct®



Note: This feature is available only in some printer models.

Wi-Fi Direct® is a printing service that lets you print to any Wi-Fi Direct-ready printer.

Note: Make sure that the mobile device is connected to the printer wireless network. For more information, see [“Connecting a mobile device to the printer” on page 28](#).

1 From your mobile device, launch a compatible application or select a document from your file manager.

2 Depending on your mobile device, do one of the following:

- Tap  > **Print**.
- Tap  > **Print**.
- Tap  > **Print**.

3 Select a printer, and then adjust the settings, if necessary.

4 Print the document.

Configuring confidential jobs

1 Open a web browser, and then type the printer IP address in the address field.

Notes:

- View the printer IP address on the home screen. The IP address appears as four sets of numbers separated by periods, such as 123.123.123.123.
- If you are using a proxy server, then temporarily disable it to load the web page correctly.

2 Click **Settings** > **Security** > **Confidential Print Setup**.

3 Configure the settings.

Use	To
Max Invalid PIN	Set the number of times an invalid PIN can be entered. Note: When the limit is reached, the print jobs for that user name are deleted.
Confidential Job Expiration	Set the expiration time for confidential print jobs. Note: Confidential held jobs are stored in the printer until they are released or deleted manually.
Repeat Job Expiration	Set the expiration time for a repeat print job. Note: Repeat held jobs are stored in the printer memory for reprinting.
Verify Job Expiration	Set the expiration time that the printer prints a copy before printing the remaining copies. Note: Verify jobs print one copy to check if it is satisfactory before printing the remaining copies.
Reserve Job Expiration	Set the expiration time that the printer stores print jobs. Note: Reserve held jobs are automatically deleted after printing.
Require All Jobs to be Held	Set the printer to hold all print jobs.
Keep duplicate documents	Set the printer to print all documents with the same file name.

Printing confidential and other held jobs

For Windows users

- 1 With a document open, click **File > Print**.
- 2 Select a printer, and then click **Properties, Preferences, Options, or Setup**.
- 3 Click **Print and Hold**.
- 4 Select **Use Print and Hold**, and then assign a user name.
- 5 Select the print job type (Confidential, Repeat, Reserve, or Verify).
If you select **Confidential**, then secure the print job with a personal identification number (PIN).
- 6 Click **OK** or **Print**.
- 7 From the printer control panel, release the print job.
 - For confidential print jobs, navigate to:
Held jobs > **OK** > select your user name > **OK** > **Confidential** > **OK** > enter the PIN > **OK** > select the print job > **OK** > configure the settings > **OK** > **Print** > **OK**
 - For other print jobs, navigate to:
Held jobs > **OK** > select your user name > **OK** > select the print job > **OK** > configure the settings > **OK** > **Print** > **OK**

For Macintosh users

Using AirPrint

- 1 With a document open, choose **File > Print**.
- 2 Select a printer, and then from the drop-down menu following the Orientation menu, choose **PIN Printing**.
- 3 Enable **Print with PIN**, and then enter a four-digit PIN.
- 4 Click **Print**.
- 5 From the printer control panel, release the print job. Navigate to:
Held jobs > **OK** > select your computer name > **OK** > **Confidential** > **OK** > enter the PIN > **OK** > select the print job > **OK** > **Print** > **OK**

Using the print driver

- 1 With a document open, choose **File > Print**.
- 2 Select a printer, and then from the drop-down menu following the Orientation menu, choose **Print and Hold**.
- 3 Choose **Confidential Print**, and then enter a four-digit PIN.
- 4 Click **Print**.
- 5 From the printer control panel, release the print job. Navigate to:
Held jobs > **OK** > select your computer name > **OK** > **Confidential** > **OK** > **OK** > select the print job > **OK** > enter the PIN > **OK** > **Print** > **OK**

Printing a font sample list



- 1 From the control panel, navigate to:
Settings > **OK** > **Reports** > **OK** > **Print** > **OK** > **Print Fonts** > **OK**
- 2 Select a font sample, and then press **OK**.

Placing separator sheets between copies

- 1 From the control panel, navigate to:
Settings > **OK** > **Print** > **OK** > **Layout** > **OK** > **Separator Sheets** > **OK** > **Between Copies** > **OK**
- 2 Print the document.

Canceling a print job

From the printer control panel

- 1 From the control panel, press  twice, and then press .
- 2 Select a print job to cancel, and then press **OK**.

From the computer

- 1 Depending on the operating system, do either of the following:
 - Open the printers folder, and then select your printer.
 - From the System Preferences in the Apple menu, navigate to your printer.
- 2 Select a print job to cancel.

Adjusting toner darkness

- 1 From the control panel, navigate to:
Settings > OK > Print > OK > Quality > OK > Toner Darkness > OK
- 2 Adjust the setting, and then press **OK**.

Use printer menus

Menu map

Device	<ul style="list-style-type: none"> • Preferences • Eco-Mode • Notifications • Power Management 	<ul style="list-style-type: none"> • Anonymous Data Collection • Restore Factory Defaults • Maintenance • About this Printer
Print	<ul style="list-style-type: none"> • Layout • Setup • Quality 	<ul style="list-style-type: none"> • PostScript • PCL • Image
Paper	<ul style="list-style-type: none"> • Tray Configuration 	<ul style="list-style-type: none"> • Media Configuration
Network/Ports	<ul style="list-style-type: none"> • Network Overview • Wireless • Wi-Fi Direct • Ethernet • TCP/IP • SNMP 	<ul style="list-style-type: none"> • IPSec • 802.1x • LPD Configuration • HTTP/FTP Settings • USB • Restrict external network access
Security*	<ul style="list-style-type: none"> • Login methods • Certificate Management • Login Restrictions 	<ul style="list-style-type: none"> • Confidential Print Setup • Erase Temporary Data Files • Miscellaneous
Reports	<ul style="list-style-type: none"> • Menu Settings Page • Device 	<ul style="list-style-type: none"> • Print • Network
Troubleshooting	Print Quality Test Pages	
* Can be configured only from the Embedded Web Server.		

Device

Preferences

Menu item	Description
Display Language	Set the language of the text that appears on the display.
Country/Region	Identify the country or region that the printer is configured to operate.
Run Initial Setup Yes No*	Run the setup wizard.
Note: An asterisk (*) next to a value indicates the factory default setting.	

Menu item	Description
Displayed information Display Text 1 Display Text 2	Specify the information to appear on the home screen.
Date and Time Configure Current Date and Time Manually Set Date and Time Date Format [MM-DD-YYYY*] Time Format [12 hour A.M./P.M.*] Time Zone [USA/Canada EST*] Network Time Protocol Enable NTP NTP Server	Configure the printer date and time.
Paper Sizes U.S.* Metric	Specify the unit of measurement for paper sizes. Note: The country or region selected in the initial setup wizard determines the initial paper size setting.
Screen Timeout 5–300 (60*)	Set the idle time in seconds before the display shows the home screen, or before the printer logs out a user account automatically.
Note: An asterisk (*) next to a value indicates the factory default setting.	

Eco-Mode

Menu item	Description
Print Sides 1-Sided* 2-Sided	Specify whether to print on one side or two sides of the paper.
Print Pages per Side Off* 2 pages per side 3 pages per side 4 pages per side 6 pages per side 9 pages per side 12 pages per side 16 pages per side	Print multiple page images on one side of a sheet of paper.
Note: An asterisk (*) next to a value indicates the factory default setting.	

Menu item	Description
Print Toner Darkness Light Normal* Dark	Determine the lightness or darkness of text images.
Note: An asterisk (*) next to a value indicates the factory default setting.	

Notifications

Menu item	Description
Supplies Show Supply Estimates Show estimates* Do not show estimates	Show the estimated status of the supplies.
Supplies Custom Supply Notifications	Configure notification settings when the printer requires user intervention. Note: This menu item appears only in the Embedded Web Server.
E-mail Alerts Setup E-mail Setup Primary SMTP Gateway Primary SMTP Gateway Port (25*) Secondary SMTP Gateway Secondary SMTP Gateway Port (25*) SMTP Timeout (30 seconds*) Reply Address Always use SMTP default Reply Address (Off*) Use SSL/TLS (Disabled*) Require Trusted Certificate (On*) SMTP Server Authentication (No authentication required*) Device-Initiated E-mail (None*) Device Userid Device Password NTLM Domain	Configure the e-mail settings of the printer. Note: This menu item appears only in the Embedded Web Server.
Error Prevention Jam Assist Off On*	Set the printer to check for jammed paper automatically.
Note: An asterisk (*) next to a value indicates the factory default setting.	

Menu item	Description
Error Prevention Auto Continue Disabled 5–255 (5*)	Let the printer continue processing or printing a job automatically after clearing certain attendance conditions.
Error Prevention Auto Reboot Auto Reboot (Reboot always*)	Set the printer to restart when an error occurs.
Error Prevention Auto Reboot Max Auto Reboots (2*)	Set the number of automatic reboots that the printer can perform.
Error Prevention Auto Reboot Auto Reboot Window (720*)	Set the number of seconds before the printer performs an automatic reboot.
Error Prevention Auto Reboot Auto Reboot Counter	Show a read-only information of the reboot counter.
Error Prevention Display Short Paper Error Auto-clear* On	Set the printer to show a message when a short paper error occurs. Note: Short paper refers to the size of the paper loaded.
Error Prevention Page Protect Off* On	Set the printer to process the entire page into the memory before printing it.
Jam Content Recovery Jam Recovery Auto* Off On	Set the printer to reprint jammed pages.

Note: An asterisk (*) next to a value indicates the factory default setting.

Power Management

Menu item	Description
Sleep Mode Profile Print from Sleep Mode Stay awake after printing Enter Sleep Mode after printing*	Set the printer to stay in Ready mode or return to Sleep mode after printing.

Note: An asterisk (*) next to a value indicates the factory default setting.

Menu item	Description
Timeouts Sleep Mode 1–120 minutes (15*)	Set the idle time before the printer begins operating in Sleep mode.
Timeouts Hibernate Timeout Disabled 1 hour 2 hours 3 hours 6 hours 1 day 2 days 3 days* 1 week 2 weeks 1 month	Set the time before the printer turns off.
Timeouts Hibernate Timeout on Connection Hibernate Do Not Hibernate*	Set Hibernate Timeout to turn off the printer while an active Ethernet connection exists.
Note: An asterisk (*) next to a value indicates the factory default setting.	

Anonymous Data Collection

Menu item	Description
Allow Anonymous Data Collection Yes No	Send printer usage and performance information to Lexmark.
Note: An asterisk (*) next to a value indicates the factory default setting.	

Restore Factory Defaults

Menu item	Description
Restore Settings Restore all settings Restore printer settings Restore network settings	Restore the printer factory default settings.

Maintenance

Config Menu

Menu item	Description
USB Configuration USB PnP 1* 2	Change the USB driver mode of the printer to improve its compatibility with a personal computer.
USB Configuration USB Speed Full Auto*	Set the USB port to run at full speed and disable its high-speed capabilities.
Tray Configuration Tray Linking Automatic* Off	Set the printer to link the trays that have the same paper type and paper size settings.
Tray Configuration Show Tray Insert Message Off Only for unknown sizes* Always	Display a message to select paper size and type after inserting the tray.
Tray Configuration A5 Loading Short Edge Long Edge*	Specify the page orientation when loading A5 paper size.
Tray Configuration Paper Prompts Auto* MP Feeder Manual Paper	Set the paper source that the user fills when a prompt to load paper appears.
Tray Configuration Envelope Prompts Auto* MP Feeder Manual Envelope	Set the paper source that the user fills when a prompt to load envelope appears.
Tray Configuration Action for Prompts Prompt user* Continue Use current	Set the printer to resolve paper- or envelope-related change prompts.

Note: An asterisk (*) next to a value indicates the factory default setting.

Menu item	Description
Reports Menu Settings Page Event Log Event Log Summary	Print reports about printer menu settings, status, and event logs.
Supply Usage And Counters Clear Supply Usage History	Reset the supply page counter or view the total printed pages.
Printer Emulations PS Emulation Off On*	Set the printer to recognize and use the PS data stream.
Printer Emulations Emulator Security Page Timeout (60*)	Set the page timeout during emulation.
Printer Emulations Emulator Security Reset Emulator After Job (Off*)	Reset the emulator after a print job.
Printer Emulations Emulator Security Disable Printer Message Access (On*)	Disable access to the printer message during emulation.
Print Configuration Font Sharpening 0–150 (24*)	Set a text point-size value below which the high-frequency screens are used when printing font data.
Print Configuration Print Density Disabled 1–5 (3*)	Adjust the toner density when printing documents.
Device Operations Quiet Mode Off* On	Set the printer to reduce the amount of noise that it makes when printing. Note: Enabling this setting slows down the overall performance of the printer.
Device Operations Panel Menus Enable* Disable	Set the printer to reduce the amount of noise that it makes when printing.
Note: An asterisk (*) next to a value indicates the factory default setting.	

Menu item	Description
Device Operations Safe Mode Off* On	Set the printer to operate in a special mode, in which it attempts to continue offering as much functionality as possible, despite known issues. For example, when set to On, and the duplex motor is nonfunctional, the printer performs one-sided printing of the documents even if the job is two-sided printing. Note: This setting cannot be used when the tray is not fully inserted or the tray sensor is damaged.
Device Operations Clear Custom Status	Erase all custom messages.
Note: An asterisk (*) next to a value indicates the factory default setting.	

Out of Service Erase

Menu item	Description
Erase Printer Memory Printer Memory Last Sanitized Sanitize all information on nonvolatile memory Erase all printer and network settings	Clear all settings and applications that are stored in the printer.

About this Printer

Menu item	Description
Asset Tag	Show the serial number of the printer.
Printer's Location	Identify the printer location. The maximum length is 63 characters.
Contact	Personalize the printer name. The maximum length is 63 characters.
Send Logs Cancel Send	Send diagnostic information to Lexmark.

Print

Layout

Menu item	Description
Sides 1-Sided* 2-Sided	Specify whether to print on one side or two sides of the paper.
Note: An asterisk (*) next to a value indicates the factory default setting.	

Menu item	Description
Flip Style Long Edge* Short Edge	Determine which side of the paper is bound when performing two-sided printing. Note: Depending on the option selected, the printer automatically offsets each printed information of the page to bind the job correctly.
Blank Pages Print Do Not Print*	Print blank pages that are included in a print job.
Collate Off [1,1,1,2,2,2]* On [1,2,1,2,1,2]	Keep the pages of a print job stacked in sequence, particularly when printing multiple copies of the job.
Separator Sheets None* Between Copies Between Jobs Between Pages	Insert blank separator sheets when printing.
Separator Sheet Source Tray [x] (1*) Multipurpose Feeder	Specify the paper source for the separator sheet.
Pages per Side Off* 2 pages per side 3 pages per side 4 pages per side 6 pages per side 9 pages per side 12 pages per side 16 pages per side	Print multiple page images on one side of a sheet of paper.
Pages per Side Ordering Horizontal* Reverse Horizontal Vertical Reverse Vertical	Specify the positioning of multiple page images when using Pages per Side. Note: The positioning depends on the number of page images and their page orientation.
Pages per Side Orientation Auto* Landscape Portrait	Specify the orientation of a multiple-page document when using Pages per Side.
Pages per Side Border None* Solid	Print a border around each page image when using Pages per Side.
Copies 1–9999 (1*)	Specify the number of copies for each print job.
Note: An asterisk (*) next to a value indicates the factory default setting.	

Menu item	Description
Print Area Normal* Whole Page	Set the printable area on a sheet of paper.
Note: An asterisk (*) next to a value indicates the factory default setting.	

Setup

Menu item	Description
Printer Language PCL Emulation* PS Emulation	Set the printer language. Note: Setting a printer language default does not prevent a software program from sending print jobs that use another printer language.
Resource Save Off* On	Determine what the printer does with downloaded resources, such as fonts and macros, when it receives a job that requires more than the available memory. Notes: <ul style="list-style-type: none"> • When set to Off, the printer retains downloaded resources only until memory is needed. Resources associated with the inactive printer language are deleted. • When set to On, the printer preserves all the permanent downloaded resources across all language switches. When necessary, the printer shows memory full messages instead of deleting permanent resources.
Print All Order Alphabetical* Newest First Oldest First	Specify the order when you choose to print all held and confidential jobs.
Note: An asterisk (*) next to a value indicates the factory default setting.	

Quality

Menu item	Description
Print Resolution 300 dpi 600 dpi* 1200 Image Q 2400 Image Q	Set the resolution for the text and images on the printed output. Note: Resolution is determined in dots per inch or image quality.
Toner Darkness Light Normal* Dark	Determine the lightness or darkness of text images.
Note: An asterisk (*) next to a value indicates the factory default setting.	

Menu item	Description
Halftone Normal* Detail	Enhance the printed output to have smoother lines with sharper edges.
Note: An asterisk (*) next to a value indicates the factory default setting.	

PostScript

Menu item	Description
Print PS Error Off* On	Print a page that describes the PostScript® error. Note: When an error occurs, processing of the job stops, the printer prints an error message, and the rest of the print job is flushed.
Minimum Line Width 1–30 (2*)	Set the minimum stroke width. Note: Jobs printed in 1200 dpi use the value directly.
Lock PS Startup Mode Off On*	Disable the SysStart file.
Wait Timeout 15–65535 (40 seconds*) Disabled	Set the printer to wait for more data before canceling a print job.
Note: An asterisk (*) next to a value indicates the factory default setting.	

PCL

Menu item	Description
Font Name [List of available fonts] (Courier*)	Select a font from the specified font source.
Symbol Set [List of available symbol set] (10U PC-8*)	Specify the symbol set for each font name. Note: A symbol set is a set of alphabetic and numeric characters, punctuation, and special symbols. Symbol sets support the different languages or specific programs such as math symbols for scientific text.
Pitch 0.08–100.00 (10.00*)	Specify the pitch for fixed or monospaced fonts. Note: Pitch refers to the number of fixed-space characters in a horizontal inch of type.
Orientation Portrait* Landscape	Specify the orientation of text and graphics on the page.
Note: An asterisk (*) next to a value indicates the factory default setting.	

Menu item	Description
Lines per Page 1–255	Specify the number of lines of text for each page printed through the PCL® data stream. Notes: <ul style="list-style-type: none"> • This menu item activates vertical escapement that causes the selected number of requested lines to print between the default margins of the page. • 60 is the U.S. factory default setting. 64 is the international factory default setting.
PCL5 Minimum Line Width 1–30 (2*)	Set the initial minimum stroke width. Note: Jobs printed in 1200 dpi use the value directly.
PCLXL Minimum Line Width 1–30 (2*)	
A4 Width 198 mm* 203 mm	Set the width of the logical page on A4-size paper. Note: Logical page is the space on the physical page where data is printed.
Auto CR after LF Off* On	Set the printer to perform a carriage return after a line feed control command. Note: Carriage return is a mechanism that commands the printer to move the position of the cursor to the first position on the same line.
Auto LF after CR Off* On	Set the printer to perform a line feed after a carriage return control command.
Tray Renumber Assign MP Feeder Assign Tray [x] Assign Manual Paper Assign Manual Envelope	Configure the printer to work with a different print driver or custom application that uses a different set of source assignments to request a given paper source. Choose from the following options: Off*—The printer uses the factory default paper source assignments. None—The paper source ignores the Select Paper Feed command. 0–199—Select a numeric value to assign a custom value to a paper source.
Tray Renumber View Factory Defaults	Show the factory default value assigned for each paper source.
Tray Renumber Restore Defaults	Restore the tray renumber values to their factory defaults.
Print Timeout 1–255 (90 seconds*) Disabled	Set the printer to end a print job after it has been idle for the specified amount of time in seconds.
Note: An asterisk (*) next to a value indicates the factory default setting.	

Image

Menu item	Description
Auto Fit On Off*	Select the best available paper size and orientation setting for an image. Note: When set to On, this menu item overrides the scaling and orientation settings for the image.
Invert Off* On	Invert bitonal monochrome images. Note: This menu item does not apply to GIF or JPEG image formats.
Scaling Anchor Top Left Best Fit* Anchor Center Fit Height/Width Fit Height Fit Width	Adjust the image to fit the printable area. Note: When Auto Fit is set to On, Scaling is automatically set to Best Fit.
Orientation Portrait* Landscape Reverse Portrait Reverse Landscape	Specify the orientation of text and graphics on the page.
Note: An asterisk (*) next to a value indicates the factory default setting.	

Paper

Tray Configuration

Menu item	Description
Default Source Tray [x] (1*) MP Feeder Manual Paper Manual Envelope	Set the paper source for all print jobs. Note: MP Feeder appears only when Configure MP is set to Cassette.
Paper Size/Type Tray [x] MP Feeder Manual Paper Manual Envelope	Specify the paper size or paper type loaded in each paper source.
Note: An asterisk (*) next to a value indicates the factory default setting.	

Menu item	Description
Substitute Size Off Letter/A4 All Listed*	Set the printer to substitute a specified paper size if the requested size is not loaded in any paper source. Notes: <ul style="list-style-type: none"> • Off prompts the user to load the required paper size. • Letter/A4 prints A4-size document on letter when loading letter, and letter-size jobs on A4 paper size when loading A4. • All Listed substitutes Letter/A4.
Configure MP Cassette* Manual First	Set the printer when to pick paper loaded in the multipurpose feeder. Notes: <ul style="list-style-type: none"> • When set to Cassette, the printer treats the multipurpose feeder like a tray. • When set to Manual, the printer treats the multipurpose feeder like a manual feeder. • When set to First, the printer picks paper from the multipurpose feeder until it is empty, regardless of the required paper source or paper size.
Note: An asterisk (*) next to a value indicates the factory default setting.	

Media Configuration

Universal Setup

Menu item	Description
Units of Measure Inches Millimeters	Specify the unit of measurement for the universal paper. Note: Inches is the U.S. factory default setting. Millimeters is the international factory default setting.
Portrait Width 3.90–14.17 inches (8.50*) 99–360 mm (216*)	Set the portrait width of the universal paper.
Portrait Height 3.90–14.17 inches (14*) 99–360 mm (356*)	Set the portrait height of the universal paper.
Feed Direction Short Edge* Long Edge	Set the printer to pick paper from the short edge or long edge direction. Note: Long Edge appears only when the longest edge is shorter than the maximum width supported.
Note: An asterisk (*) next to a value indicates the factory default setting.	

Media Types

Menu item	Description
Plain Paper Card Stock Recycled Labels Bond Envelope Rough Envelope Letterhead Preprinted Colored Paper Light Heavy Rough/Cotton Custom Type [X]	Specify the texture, weight, and orientation of the paper loaded.

Network/Ports

Network Overview

Menu item	Description
Active Adapter Auto* Standard Network Wireless	Specify the type of the network connection.
Network Status	Show the connectivity status of the printer network.
Display Network Status on Printer Off On*	Show the network status on the display.
Speed, Duplex	Show the speed of the currently active network card.
IPv4	Show the IPv4 address.
All IPv6 Addresses	Show all IPv6 addresses.
Reset Print Server Start	Reset all active network connections to the printer. Note: This setting removes all network configuration settings.
Network Job Timeout Off On* (90 seconds)	Set the time before the printer cancels a network print job.
Note: An asterisk (*) next to a value indicates the factory default setting.	

Menu item	Description
Banner Page Off* On	Print a banner page.
Enable Network Connections Enable* Disable	Enable or disable all network connections.
Enable LLDP Off* On	Enable Link Layer Discovery Protocol (LLDP) in the printer.
Note: An asterisk (*) next to a value indicates the factory default setting.	

Wireless

Menu item	Description
Setup Using Mobile App	Configure the wireless connection using the Lexmark Mobile Assistant app.
Setup On Printer Panel Choose Network Add Wi-Fi Network <ul style="list-style-type: none"> • Network Name • Network Mode • Wireless Security Mode (Disabled*) 	Determine the wireless network that the printer connects to. Note: This menu item appears as <i>Wireless Connection Setup</i> in the Embedded Web Server.
Wi-Fi Protected Setup Start Push Button Method Start PIN Method	Establish a wireless network and enable network security. Notes: <ul style="list-style-type: none"> • Start Push Button Method connects the printer to a wireless network when buttons on both the printer and the access point (wireless router) are pressed within a given time. • Start PIN Method connects the printer to a wireless network when a PIN on the printer is entered into the wireless settings of the access point.
Compatibility 802.11b/g/n (2.4GHz)*	Specify the wireless standard for the wireless network.
Wireless Security Mode Disabled* WEP WPA2/WPA-Personal WPA2-Personal 802.1x - RADIUS	Set the type of security for connecting the printer to wireless devices.
WEP Authentication Mode Auto* Open Shared	Set the type of Wireless Encryption Protocol (WEP) used by the printer. Note: This menu item appears only if Wireless Security Mode is set to WEP.

Menu item	Description
Set WEP Key	Specify a WEP password for secure wireless connection. Note: This menu item appears only if Wireless Security Mode is set to WEP.
WPA2-Personal AES*	Enable wireless security through WPA2. Note: This menu item appears only if Wireless Security Mode is set to WPA2-Personal.
Set PSK	Set the password for secure wireless connection. Note: This menu item appears only if Wireless Security Mode is set to WPA2/WPA-Personal or WPA2-Personal.
WPA2/WPA-Personal AES*	Enable wireless security through WPA2/WPA. Note: This menu item appears only if Wireless Security Mode is set to WPA2/WPA-Personal.
802.1x Encryption Mode WPA+ WPA2*	Enable wireless security through 802.1x standard. Note: This menu item appears only if Wireless Security Mode is set to 802.1x - Radius.
IPv4 Enable DHCP On* Off	Enable Dynamic Host Configuration Protocol (DHCP). Note: DHCP is a standard protocol that lets a server dynamically assign an IP address and other network configuration parameters to each device on the network, so that they can communicate with other IP networks.
IPv4 Set Static IP Address IP Address Netmask Gateway	Set the static IP address of your printer.
IPv6 Enable IPv6 On* Off	Enable IPv6 in the printer.
IPv6 Enable DHCPv6 Off* On	Enable DHCPv6 in the printer.
IPv6 Stateless Address Autoconfiguration Off On*	Set the network adapter to accept the automatic IPv6 address configuration entries provided by a router.
IPv6 DNS Address	Specify the DNS server address.
IPv6 Manually Assigned IPV6	Assign the IPv6 address. Note: This menu item appears only in some printer models.

Menu item	Description
IPv6 Manually Assigned IPV6 Router	Assign the IPv6 router address. Note: This menu item appears only in some printer models.
IPv6 Address Prefix 0–128 (64*)	Specify the address prefix.
IPv6 All IPv6 Addresses	Show all IPv6 addresses.
IPv6 All IPv6 Router Addresses	Show all IPv6 router addresses.
Network Address UAA LAA	View the network addresses.
PCL SmartSwitch On* Off	Set the printer to switch automatically to PCL emulation when a print job requires it, regardless of the default printer language. Note: If PCL SmartSwitch is off, then the printer does not examine incoming data and uses the default printer language specified in the Setup menu.
PS SmartSwitch On* Off*	Set the printer to switch automatically to PS emulation when a print job requires it, regardless of the default printer language. Notes: <ul style="list-style-type: none"> This menu item appears only in some printer models. If PS SmartSwitch is off, then the printer does not examine incoming data and uses the default printer language specified in the Setup menu.
Mac Binary PS Auto* On Off	Set the printer to process Macintosh binary PostScript print jobs. Notes: <ul style="list-style-type: none"> This menu item appears only in some printer models. On processes raw binary PostScript print jobs. Off filters print jobs using the standard protocol.

Wi-Fi Direct

Menu item	Description
Enable Wi-Fi Direct On Off*	Set the printer to connect directly to Wi-Fi devices.
Wi-Fi Direct Name	Specify the name of the Wi-Fi Direct network.
Wi-Fi Direct Password	Set the password to authenticate and validate users on a Wi-Fi connection.
Note: An asterisk (*) next to a value indicates the factory default setting.	

Menu item	Description
Show Password on Setup Page Off On*	Show the Wi-Fi Direct Password on the Network Setup Page.
Preferred Channel Number 1–11 Auto*	Set the preferred channel of the Wi-Fi network.
Group Owner IP Address	Specify the IP address of the group owner.
Auto-Accept Push Button Requests Off* On	Accept requests to connect to the network automatically. Note: Accepting clients automatically is not secured.
Note: An asterisk (*) next to a value indicates the factory default setting.	

Ethernet

Menu item	Description
Network Speed	Show the speed of an active network adapter.
IPv4 Enable DHCP On* Off	Enable Dynamic Host Configuration Protocol (DHCP). Note: DHCP is a standard protocol that allows a server to distribute IP addressing and configuration information to clients in a dynamic manner.
IPv4 Set Static IP Address IP Address Netmask Gateway	Set the static IP address of your printer.
IPv6 Enable IPv6 On* Off	Enable IPv6 in the printer.
IPv6 Enable DHCPv6 Off* On	Enable DHCPv6 in the printer.
IPv6 Stateless Address Autoconfiguration On* Off	Set the network adapter to accept the automatic IPv6 address configuration entries provided by a router.
Note: An asterisk (*) next to a value indicates the factory default setting.	

Menu item	Description
IPv6 DNS Address	Specify the DNS server address.
IPv6 Address Prefix 0–128 (64*)	Specify the address prefix.
IPv6 All IPv6 Addresses	Show all IPv6 addresses.
IPv6 All IPv6 Router Addresses	Show all IPv6 router addresses.
Network Address UAA LAA	Show the printer Media Access Control (MAC) addresses: Locally Administered Address (LAA) and Universally Administered Address (UAA). Note: You can change the printer LAA manually.
PCL SmartSwitch On* Off	Set the printer to switch automatically to PCL emulation when a print job requires it, regardless of the default printer language. Note: If PCL SmartSwitch is off, then the printer does not examine incoming data and uses the default printer language specified in the Setup menu.
PS SmartSwitch On* Off	Set the printer to switch automatically to PS emulation when a print job requires it, regardless of the default printer language. Note: If PS SmartSwitch is off, then the printer does not examine incoming data and uses the default printer language specified in the Setup menu.
Mac Binary PS Auto* On Off	Set the printer to process Macintosh binary PostScript print jobs. Notes: <ul style="list-style-type: none"> • On processes raw binary PostScript print jobs. • Off filters print jobs using the standard protocol.
Energy Efficient Ethernet Auto* On Off	Reduce power consumption when the printer does not receive data from the Ethernet network.
Note: An asterisk (*) next to a value indicates the factory default setting.	

TCP/IP

Note: This menu appears only in network printers or printers that are attached to print servers.

Menu item	Description
Set Hostname	Set the current TCP/IP host name.
Allow DHCP/BOOTP to update NTP server On* Off	Allow the DHCP and BOOTP clients to update the NTP settings of the printer.
Note: An asterisk (*) next to a value indicates the factory default setting.	

Menu item	Description
Enable Auto IP On* Off	Assign an IP address automatically.
DNS Address	Specify the current Domain Name System (DNS) server address.
Backup DNS	Specify the backup DNS server addresses.
Backup DNS 2	
Backup DNS 3	
Enable DDNS Off* On	Update the Dynamic DNS settings.
DDNS TTL	Specify the current DDNS settings.
Default TTL	
DDNS Refresh Time	
Enable mDNS On* Off	Update multicast DNS settings.
WINS Address	Specify a server address for Windows Internet Name Service (WINS).
Enable BOOTP On Off*	Allow the BOOTP to assign a printer IP address.
MTU	Specify a maximum transmission unit (MTU) parameter for the TCP connections.
Raw Print Port 1–65535 (9100*)	Specify a raw port number for printers connected on a network.
Outbound Traffic Maximum Speed On Off*	Enable the printer maximum transfer rate.
Enable TLSv1.0 On* Off	Enable the TLSv1.0 protocol.
Enable TLSv1.1 On* Off	Enable the TLSv1.1 protocol.
SSL Cipher List	Specify the cipher algorithms to use for the SSL or the TLS connections.
Note: An asterisk (*) next to a value indicates the factory default setting.	

SNMP

Note: This menu appears only in network printers or printers that are attached to print servers.

Menu item	Description
SNMP Versions 1 and 2c Enabled Off On* Allow SNMP Set Off On* Enable PPM MIB Off On* SNMP Community	Configure Simple Network Management Protocol (SNMP) versions 1 and 2c to install print drivers and applications.
SNMP Version 3 Enabled Off On* Context Name Set Read/Write Credentials User Name Authentication Password Privacy Password Set Read-only Credentials User Name Authentication Password Privacy Password Authentication Hash MD5 SHA1* Minimum Authentication Level No Authentication, No Privacy Authentication, No Privacy Authentication, Privacy* Privacy Algorithm DES AES-128*	Configure SNMP version 3 to install and update the printer security.
Note: An asterisk (*) next to a value indicates the factory default setting.	

IPSec

Note: This menu appears only in network printers or printers that are attached to print servers.

Menu item	Description
Enable IPsec Off* On	Enable Internet Protocol Security (IPsec).
Base Configuration Default* Compatibility Secure	Set the IPsec base configuration. Note: This menu item appears only when Enable IPsec is set to On.
DH (Diffie-Hellman) Group Proposal modp2048 (14)* modp3072 (15) modp4069 (16) modp6144 (17)	Set the IPsec encryption. Notes: <ul style="list-style-type: none"> DH (Diffie-Hellman) Group Proposal appears only when Base Configuration is set to Compatibility. IKE SA Lifetime (Hours) and IPsec SA Lifetime (Hours) appear only when Base Configuration is set to Secure.
IKE SA Lifetime (Hours) 1 2 4 8 24*	
IPsec SA Lifetime (Hours) 1 2 4 8* 24	
Proposed Encryption Method 3DES AES*	Specify the encryption and authentication methods to connect to a network securely. Note: These menu items appear only when Base Configuration is set to Compatibility.
Proposed Authentication Method SHA1 SHA256* SHA512	
IPsec Device Certificate	Specify an IPsec certificate. Note: This menu item appears only when Enable IPsec is set to On.
Note: An asterisk (*) next to a value indicates the factory default setting.	

Menu item	Description
Pre-Shared Key Authenticated Connections Host [x] Address Key	Configure the authenticated connections of the printer. Note: These menu items appear only when Enable IPsec is set to On.
Certificate Authenticated Connections Host [x] Address[/subnet] Address[/subnet]	
Note: An asterisk (*) next to a value indicates the factory default setting.	

802.1x

Note: This menu appears only in network printers or printers that are attached to print servers.

Menu item	Description
Active Off* On	Let the printer join networks that require authentication before allowing access.
Note: An asterisk (*) next to a value indicates the factory default setting.	

LPD Configuration

Note: This menu appears only in network printers or printers that are attached to print servers.

Menu item	Description
LPD Timeout 0–65535 seconds (90*)	Set the time-out value to stop the Line Printer Daemon (LPD) server from waiting indefinitely for hung or invalid print jobs.
LPD Banner Page Off* On	Print a banner page for all LPD print jobs. Note: A banner page is the first page of a print job used as a separator of print jobs and to identify the originator of the print job request.
LPD Trailer Page Off* On	Print a trailer page for all LPD print jobs. Note: A trailer page is the last page of a print job.
LPD Carriage Return Conversion Off* On	Enable carriage return conversion. Note: Carriage return is a mechanism that commands the printer to move the position of the cursor to the first position on the same line.
Note: An asterisk (*) next to a value indicates the factory default setting.	

HTTP/FTP Settings

Menu item	Description
Enable HTTP Server Off On*	Access the Embedded Web Server to monitor and manage the printer.
Enable HTTPS Off On*	Configure the Hypertext Transfer Protocol Secure (HTTPS) settings.
Force HTTPS Connections On Off*	Force the printer to use the HTTPS connections.
Enable FTP/TFTP Off On*	Send files using FTP.
Local Domains	Specify domain names for HTTP and FTP servers. Note: This menu item appears only in the Embedded Web Server.
HTTP Proxy IP Address	Configure the HTTP and FTP server settings.
FTP Proxy IP Address	Note: HTTP Proxy IP Address and FTP Proxy IP Address appear only in the Embedded Web Server.
HTTP Default IP Port 1–65535 (80*)	
HTTPS Device Certificate	
FTP Default IP Port 1–65535 (21*)	
Timeout for HTTP/FTP Requests 1–299 (30*)	
Retries for HTTP/FTP Requests 1–299 (3*)	Set the number of retries to connect to the HTTP/FTP server.
Note: An asterisk (*) next to a value indicates the factory default setting.	

USB

Menu item	Description
PCL SmartSwitch Off On*	Set the printer to switch to PCL emulation when a print job received through a USB port requires it, regardless of the default printer language. Note: If PCL SmartSwitch is off, then the printer does not examine incoming data and uses the default printer language specified in the Setup menu.
Note: An asterisk (*) next to a value indicates the factory default setting.	

Menu item	Description
PS SmartSwitch Off On*	Set the printer to switch to PS emulation when a print job received through a USB port requires it, regardless of the default printer language. Note: If PS SmartSwitch is off, then the printer does not examine incoming data and uses the default printer language specified in the Setup menu.
Mac Binary PS On Auto* Off	Set the printer to process Macintosh binary PostScript print jobs. Notes: <ul style="list-style-type: none"> • When set to On, the printer processes raw binary PostScript print jobs from computers using the Macintosh operating system. • When set to Auto, the printer processes print jobs from computers using either Windows or Macintosh operating systems • When set to Off, the printer filters PostScript print jobs using the standard protocol.
Enable USB Port Disable Enable*	Enable the standard USB port.
Note: An asterisk (*) next to a value indicates the factory default setting.	

Restrict external network access

Menu item	Description
Restrict external network access Off* On	Restrict access to network sites.
External network address	Specify the network addresses with restricted access.
E-mail address for notification	Specify an e-mail address to send a notification of logged events.
Ping frequency 1–300 (10*)	Specify the network query interval in seconds.
Subject	Specify the subject and message of the notification e-mail.
Message	
Note: An asterisk (*) next to a value indicates the factory default setting.	

Security

Login Methods

Public

Menu item	Description
Manage Permissions Function Access Held Jobs Access Cancel Jobs at the Device Change Language Internet Printing Protocol (IPP) B/W Print	Control access to the printer functions.
Manage Permissions Administrative Menu Security Menu Network/Ports Menu Paper Menu Reports Menu Function Configuration Menus Supplies Menu SE Menu Device Menu	Control access to the printer menus.
Manage Permissions Device Management Remote Management Firmware Updates Import / Export All Settings Out of Service Erase Embedded Web Server Access	Control access to the printer management options.

Local Accounts

Menu item	Description
Add User User Name/Password User Name Password PIN	Create local accounts to manage access to the printer functions.

Menu item	Description
Manage Groups/Permissions Add Group Import Access Controls Function Access Administrative Menus Device Management All Users Import Access Controls Function Access Administrative Menus Device Management Admin Function Access Administrative Menus Device Management	Control group or user access to the printer functions, applications, and security settings.

Certificate Management

Menu item	Menu item
Configure Certificate Defaults Common Name Organization Name Unit Name Country/Region Province Name City Name Subject Alternate Name	Set the default values for generated certificates.
Device Certificates	Generate, delete, or view device certificates.
Manage CA Certificates	Load, delete, or view Certificate Authority (CA) certificates.

Login Restrictions

Menu item	Description
Login failures 1–10 (3*)	Specify the number of failed login attempts before the user gets locked out.
Failure time frame 1–60 minutes (5*)	Specify the time frame between failed login attempts before the user gets locked out.
Lockout time 1–60 minutes (5*)	Specify the lockout duration.
Web Login Timeout 1–120 minutes (10*)	Specify the delay for a remote login before the user is logged off automatically.
Note: An asterisk (*) next to a value indicates the factory default setting.	

Confidential Print Setup

Menu item	Description
Max Invalid PIN 2–10 (0*)	Set the number of times an invalid PIN can be entered. Notes: <ul style="list-style-type: none"> • A value of zero turns off this setting. • When the limit is reached, the print jobs for that user name and PIN are deleted.
Confidential Job Expiration Off* 1 Hour 4 Hours 24 Hours 1 Week	Set the expiration time for confidential print jobs. Notes: <ul style="list-style-type: none"> • If this menu item is changed while confidential print jobs reside in the printer memory, then the expiration time for those print jobs does not change to the new default value. • If the printer is turned off, then all confidential jobs held in the printer memory are deleted.
Repeat Job Expiration Off* 1 Hour 4 Hours 24 Hours 1 Week	Set the expiration time for a print job that you want to repeat.
Verify Job Expiration Off* 1 Hour 4 Hours 24 Hours 1 Week	Set the expiration time that the printer prints a copy for the user to examine its quality, before printing the remaining copies.
Reserve Job Expiration Off* 1 Hour 4 Hours 24 Hours 1 Week	Set the expiration time that the printer stores print jobs for printing later.
Require All Jobs to be Held Off* On	Set the printer to hold all print jobs.
Keep duplicate documents Off* On	Allow the storage of documents with the same file name.
Note: An asterisk (*) next to a value indicates the factory default setting.	

Erase Temporary Data Files

Menu item	Description
Stored in onboard memory Off* On	Delete all files stored on the printer memory.
Note: An asterisk (*) next to a value indicates the factory default setting.	

Miscellaneous

Menu item	Description
Print Permission Off* On	Allow the user to print.
Security Reset Jumper Enable "Guest" access* No Effect	Specify user access to the printer. Notes: <ul style="list-style-type: none"> • The jumper is located beside a lock icon on the controller board. • Enable "Guest" access gives anyone access to all aspects of the printer. • No Effect may make access to the printer impossible when the required security information is unavailable.
Minimum Password Length 0–32	Specify the password length.
Note: An asterisk (*) next to a value indicates the factory default setting.	

Reports

Menu Settings Page

Menu item	Description
Menu Settings Page	Print a report that contains the printer menus.

Device

Menu item	Description
Device Information	Print a report that contains information about the printer.
Device Statistics	Print a report about printer usage and supply status.
Profile List	Print a list of profiles that are stored in the printer.
Asset Report	Print a report that contains the printer serial number and model name.

Print

Menu item	Description
Print Fonts PCL Fonts PostScript Fonts	Print samples and information about the fonts that are available in each printer language.

Network

Menu item	Description
Network Setup Page	Print a page that shows the configured network and wireless settings on the printer. Note: This menu item appears only in network printers or printers connected to print servers.
Wi-Fi Direct Connected Clients	Print a page that shows the list of devices that are connected to the printer using Wi-Fi Direct. Note: This menu item appears only when Enable Wi-Fi Direct is set to On.

Troubleshooting

Menu item	Description
Print Quality Test Pages	Print sample pages to identify and correct print quality defects.

Maintain the printer

Checking the status of parts and supplies

1 From the control panel, navigate to:

Settings > **OK** > **Reports** > **OK** > **Device** > **OK** > **Device Statistics** > **OK**

2 From the Supply Information section of the pages printed, check the status of parts and supplies.

Configuring supply notifications

1 Open a web browser, and then type the printer IP address in the address field.

Notes:

- View the printer IP address on the printer home screen. The IP address appears as four sets of numbers separated by periods, such as 123.123.123.123.
- If you are using a proxy server, then temporarily disable it to load the web page correctly.

2 Click **Settings** > **Device** > **Notifications**.

3 From the Supplies menu, click **Custom Supply Notifications**.

4 Select a notification for each supply item.

5 Apply the changes.

Setting up e-mail alerts

Configure the printer to send e-mail alerts when supplies are low, when paper must be changed or added, or when there is a paper jam.

1 Open a web browser, and then type the printer IP address in the address field.

Notes:

- View the printer IP address on the printer home screen. The IP address appears as four sets of numbers separated by periods, such as 123.123.123.123.
- If you are using a proxy server, then temporarily disable it to load the web page correctly.

2 Click **Settings** > **Device** > **Notifications** > **E-mail Alert Setup**, and then configure the settings.

3 Click **Setup E-mail Lists and Alerts**, and then configure the settings.

4 Apply the changes.

Note: For more information on SMTP server settings, contact your e-mail provider.

Viewing reports

You can view some reports from the Embedded Web Server. These reports are useful for assessing the status of the printer, network, and supplies.

- 1 Open a Web browser, and then type the printer IP address in the address field.

Notes:

- View the printer IP address on the printer home screen. The IP address appears as four sets of numbers separated by periods, such as 123.123.123.123.
- If you are using a proxy server, then temporarily disable it to load the Web page correctly.

- 2 Click **Reports**, and then click the type of report you want to view.

Ordering parts and supplies

To order supplies in the U.S., contact Lexmark at 1-800-539-6275 for information about Lexmark authorized supplies dealers in your area. In other countries or regions, go to www.lexmark.com or contact the place where you purchased the printer.

Note: All life estimates for printer supplies assume printing on letter- or A4-size plain paper.

Warning—Potential Damage: Failure to maintain optimum printer performance, or to replace parts and supplies, may cause damage to your printer.

Using genuine Lexmark parts and supplies

Your Lexmark printer is designed to function best with genuine Lexmark parts and supplies. Use of third-party supplies or parts may affect the performance, reliability, or life of the printer and its imaging components. It can also affect warranty coverage. Damage caused by the use of third-party parts and supplies is not covered by the warranty. All life indicators are designed to function with Lexmark parts and supplies, and may deliver unpredictable results if third-party parts and supplies are used. Imaging component usage beyond the intended life may damage your Lexmark printer or its associated components.

Warning—Potential Damage: Supplies and parts without Return Program agreement terms may be reset and remanufactured. However, the manufacturer's warranty does not cover any damage caused by non-genuine supplies or parts. Resetting counters on the supply or part without proper remanufacturing can cause damage to your printer. After resetting the supply or part counter, your printer may display an error indicating the presence of the reset item.

Ordering a toner cartridge

Notes:

- The estimated cartridge yield is based on the ISO/IEC 19752 standard.
- Extremely low print coverage for extended periods of time may negatively affect actual yield.

Lexmark MS331 and MS431 Return Program toner cartridges

Item	United States and Canada	European Economic Area	Rest of Asia Pacific	Latin America	Rest of Europe, Middle East, and Africa	Australia and New Zealand
Return Program toner cartridge	55B1000	55B2000	55B3000	55B4000	55B5000	55B6000
High yield Return Program toner cartridge	55B1H00	55B2H00	55B3H00	55B4H00	55B5H00	55B6H00
Extra high yield Return Program toner cartridge ¹	55B1X00	55B2X00	55B3X00	55B4X00	55B5X00	55B6X00
Corporate Return Program toner cartridge ²	55B100E	55B200E	55B300E	55B400E	55B500E	55B600E
High yield Corporate Return Program toner cartridge ²	55B1H0E	55B2H0E	55B3H0E	55B4H0E	55B5H0E	55B6H0E
Extra high yield Corporate Return Program toner cartridge ^{1,2}	55B1X0E	55B2X0E	55B3X0E	55B4X0E	55B5X0E	55B6X0E

¹ Supported only in the Lexmark MS431 printer model.

² Available only for contract-managed printers. For more information, contact your Lexmark representative or system administrator.

Lexmark MS331 and MS431 regular toner cartridges

Item	Worldwide
High yield regular toner cartridge ¹	55B0HA0
Extra high yield regular toner cartridge ²	55B0XA0

¹ Supported only in the Lexmark MS331 printer model.

² Supported only in the Lexmark MS431 printer model.

Lexmark MS439 Return Program toner cartridge

Item	Part number
Extra high yield Return Program toner cartridge	55B3X0K
Return Program toner cartridge	55B300K

Lexmark B3340 and B3442 Return Program toner cartridges

Item	United States and Canada	European Economic Area	Rest of Asia Pacific	Latin America	Rest of Europe, Middle East, and Africa	Australia and New Zealand
Return Program toner cartridge	B341000	B342000	B343000	B344000	B345000	B346000
High yield Return Program toner cartridge	B341H00	B342H00	B343H00	B344H00	B345H00	B346H00
Extra high yield Return Program toner cartridge*	B341X00	B342X00	B343X00	B344X00	B345X00	B346X00

* Supported only in the Lexmark B3442 printer model.

Lexmark B3340 and B3442 regular toner cartridges

Item	Worldwide
High yield regular toner cartridge ¹	B340HA0
Extra high yield regular toner cartridge ²	B340XA0

¹ Supported only in the Lexmark B3340 printer model.

² Supported only in the Lexmark B3442 printer model.

Lexmark M1342 Regular toner cartridges

Item	Europe, Middle East, Africa, and Mexico	United States, Canada, and Australia
Regular toner cartridge	24B7005	24B7002

Ordering an imaging unit

Extremely low print coverage for extended periods of time may cause imaging unit parts to fail before the toner is exhausted.

Item	Part Number
Regular imaging unit	55B0ZA0

Replacing parts and supplies

Replacing the toner cartridge

- 1 Open the front door.

Warning—Potential Damage: To prevent damage from electrostatic discharge, touch any exposed metal frame of the printer before accessing or touching interior areas of the printer.

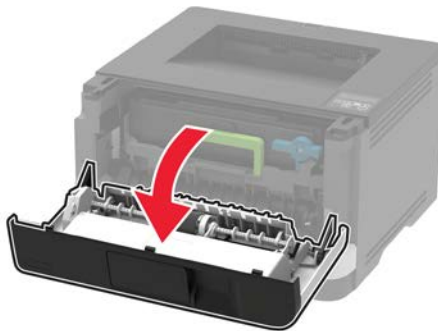

- 2 Remove the imaging unit.



- 3 Twist the blue latch, and then remove the used toner cartridge from the imaging unit.

Warning—Potential Damage: Do not expose the imaging unit to direct light for more than 10 minutes. Extended exposure to light may cause print quality problems.

Warning—Potential Damage: Do not touch the photoconductor drum. Doing so may affect the quality of future print jobs.

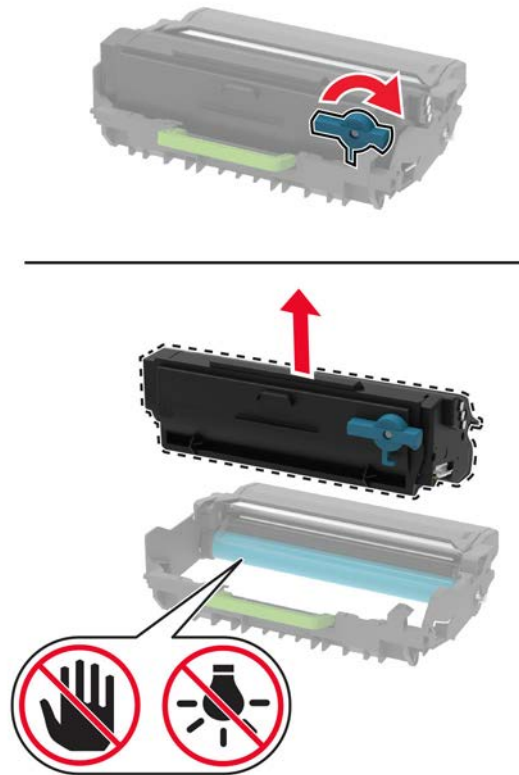

- 4 Unpack the new toner cartridge.
- 5 Shake the toner cartridge to redistribute the toner.

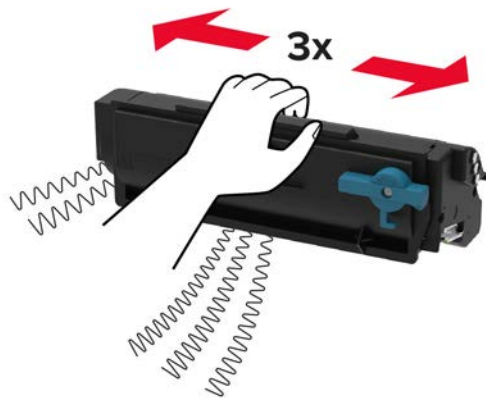

- 6 Insert the new toner cartridge into the imaging unit until it *clicks* into place.

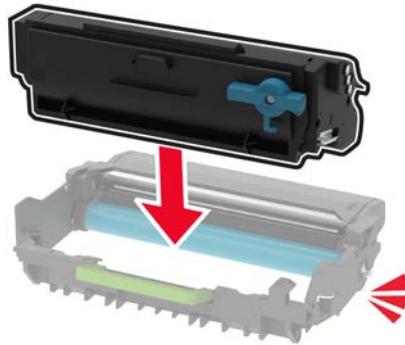

- 7 Insert the imaging unit.



- 8 Close the door.

Replacing the imaging unit

- 1 Open the front door.

Warning—Potential Damage: To prevent damage from electrostatic discharge, touch any exposed metal frame of the printer before accessing or touching interior areas of the printer.

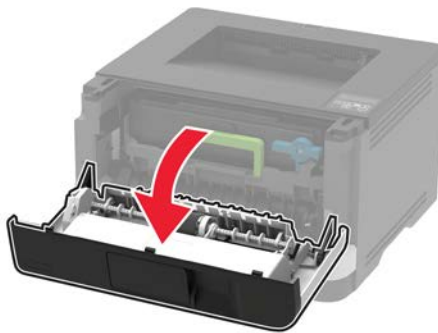

2 Remove the used imaging unit.



- 3 Twist the blue latch, and then remove the toner cartridge from the used imaging unit.

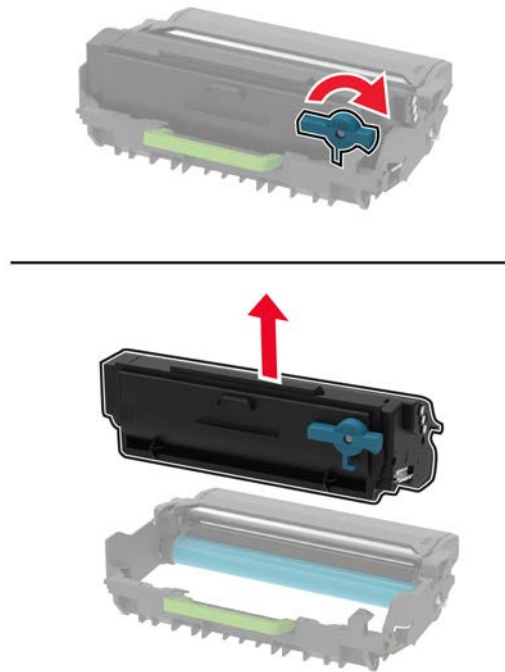

- 4 Unpack the new imaging unit, and then insert the toner cartridge until it *clicks* into place.

Warning—Potential Damage: Do not expose the imaging unit to direct light for more than 10 minutes. Extended exposure to light may cause print quality problems.

Warning—Potential Damage: Do not touch the photoconductor drum. Doing so may affect the quality of future print jobs.

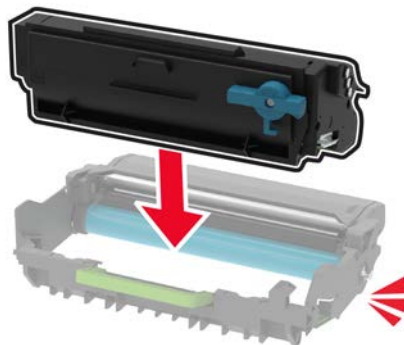

- 5 Insert the new imaging unit.



- 6 Close the door.

Replacing the tray

- 1 Remove the used tray.



- 2 Unpack the new tray.

- 3 Insert the new tray.



Replacing the pick roller assembly

- 1 Turn off the printer.
- 2 Unplug the power cord from the electrical outlet, and then from the printer.

3 Open the front door.

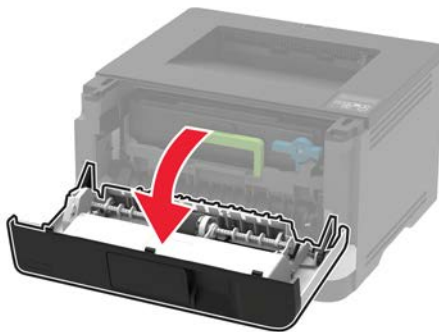

4 Remove the imaging unit.



5 Close the front door.

6 Remove the tray.



7 Position the printer on its side.

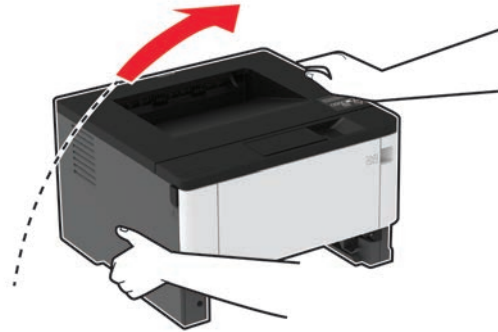

8 Remove the used pick roller assembly.

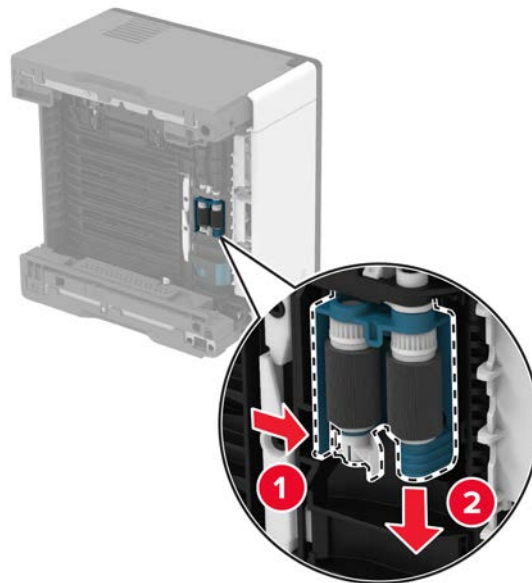

9 Unpack the new pick roller assembly.

Note: To avoid contamination, make sure that your hands are clean.

- 10** Insert the new pick roller assembly.

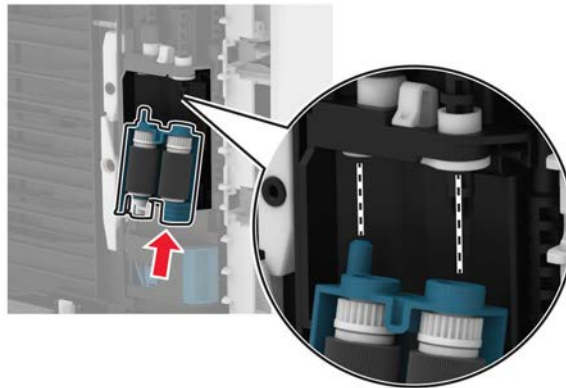

- 11** Place the printer in its original position, and then insert the tray.
- 12** Open the front door.
- 13** Insert the imaging unit.
- 14** Close the front door.
- 15** Connect the power cord to the printer, and then to the electrical outlet.
- ⚠ CAUTION—POTENTIAL INJURY:** To avoid the risk of fire or electrical shock, connect the power cord to an appropriately rated and properly grounded electrical outlet that is near the product and easily accessible.
- 16** Turn on the printer.

Replacing the tray separator roller

- 1 Remove the tray, and then remove the used separator roller.

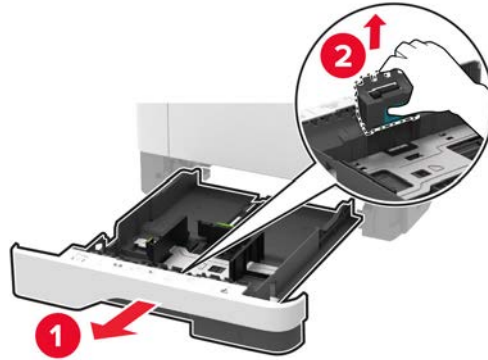

- 2 Unpack the new separator roller.

Note: To avoid contamination, make sure that your hands are clean.

- 3 Insert the new separator roller.

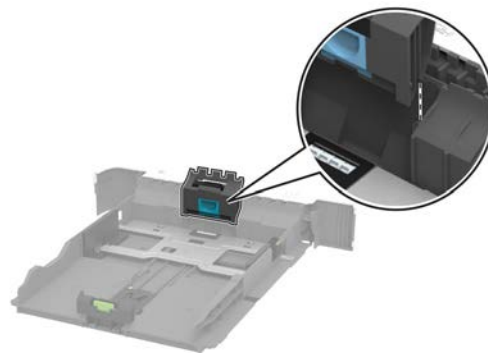

- 4 Insert the tray.



Resetting the supply usage counters

1 From the control panel, navigate to:

Settings > **OK** > **Device** > **OK** > **Maintenance** > **OK** > **Config Menu** > **OK** > **Supply Usage And Counters**
> **OK**

2 Select the counter that you want to reset.

Warning—Potential Damage: Supplies and parts without Return Program agreement terms may be reset and remanufactured. However, the manufacturer's warranty does not cover any damage caused by non-genuine supplies or parts. Resetting counters on the supply or part without proper remanufacturing can cause damage to your printer. After resetting the supply or part counter, your printer may display an error indicating the presence of the reset item.

Cleaning printer parts

Cleaning the printer

 **CAUTION—SHOCK HAZARD:** To avoid the risk of electrical shock when cleaning the exterior of the printer, unplug the power cord from the electrical outlet and disconnect all cables from the printer before proceeding.

Notes:

- Perform this task after every few months.
- Damage to the printer caused by improper handling is not covered by the printer warranty.

1 Turn off the printer, and then unplug the power cord from the electrical outlet.

2 Remove paper from the standard bin and multipurpose feeder.

3 Remove any dust, lint, and pieces of paper around the printer using a soft brush or vacuum.

4 Wipe the outside of the printer with a damp, soft, lint-free cloth.

Notes:

- Do not use household cleaners or detergents, as they may damage the finish of the printer.
- Make sure that all areas of the printer are dry after cleaning.

5 Connect the power cord to the electrical outlet, and then turn on the printer.

 **CAUTION—POTENTIAL INJURY:** To avoid the risk of fire or electrical shock, connect the power cord to an appropriately rated and properly grounded electrical outlet that is near the product and easily accessible.

Cleaning the pick roller assembly

1 Turn off the printer.

2 Unplug the power cord from the electrical outlet, and then from the printer.

3 Open the front door.

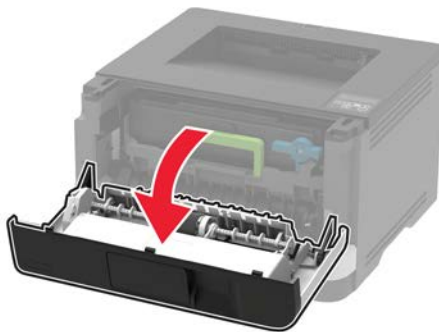

4 Remove the imaging unit.



5 Close the front door.

6 Remove the tray.



7 Position the printer on its side.

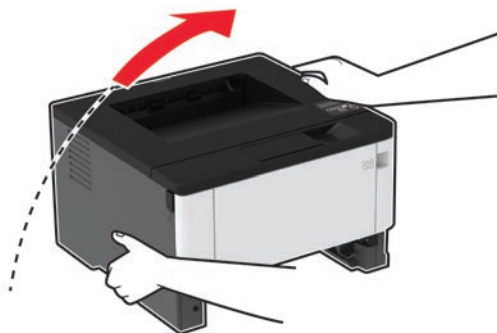

8 Remove the pick roller assembly.

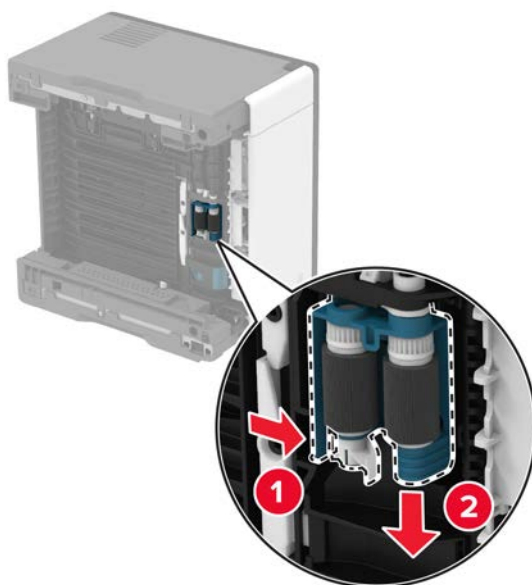

9 Apply isopropyl alcohol to a soft, lint-free cloth, and then wipe the pick roller assembly.

- 10** Insert the pick roller assembly.

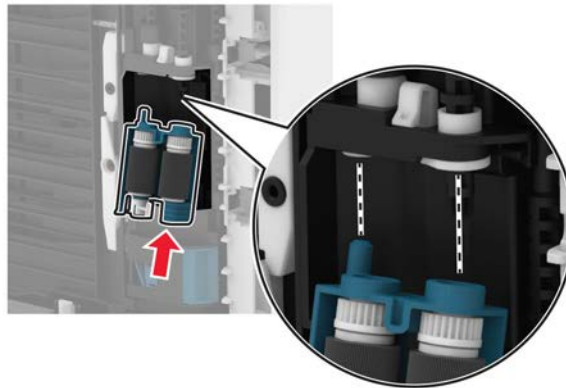

- 11** Place the printer in its original position, and then insert the tray.
- 12** Open the front door.
- 13** Insert the imaging unit.
- 14** Close the front door.
- 15** Connect the power cord to the printer, and then to the electrical outlet.
- ⚠ CAUTION—POTENTIAL INJURY:** To avoid the risk of fire or electrical shock, connect the power cord to an appropriately rated and properly grounded electrical outlet that is near the product and easily accessible.
- 16** Turn on the printer.

Saving energy and paper

Configuring the power save mode settings

Sleep mode

1 From the control panel, navigate to:

Settings > **OK** > **Device** > **OK** > **Power Management** > **OK** > **Timeouts** > **OK** > **Sleep Mode** > **OK**

2 Enter the amount of time that the printer stays idle before it enters Sleep mode.

Hibernate mode

1 From the control panel, navigate to:

Settings > **OK** > **Device** > **OK** > **Power Management** > **OK** > **Timeouts** > **OK** > **Hibernate Timeout** > **OK**

2 Select the amount of time before the printer enters Hibernate mode.

Notes:

- Make sure to wake the printer from Hibernate mode before sending a print job.
- To wake the printer from Hibernate mode, press the power button.
- The Embedded Web Server is disabled when the printer is in Hibernate mode.

Conserving supplies

- Print on both sides of the paper.

Note: Two-sided printing is the default setting in the print driver.

- Print multiple pages on a single sheet of paper.
- Use the preview feature to see how the document looks like before printing it.
- Print one copy of the document to check its content and format for accuracy.

Moving the printer to another location

 **CAUTION—POTENTIAL INJURY:** If the printer weight is greater than 20 kg (44 lb), then it may require two or more people to lift it safely.

 **CAUTION—POTENTIAL INJURY:** To avoid the risk of fire or electrical shock, use only the power cord provided with this product or the manufacturer's authorized replacement.

 **CAUTION—POTENTIAL INJURY:** When moving the printer, follow these guidelines to avoid personal injury or printer damage:

- Make sure that all doors and trays are closed.
- Turn off the printer, and then unplug the power cord from the electrical outlet.
- Disconnect all cords and cables from the printer.

- If the printer has separate floor-standing optional trays or output options attached to it, then disconnect them before moving the printer.
- If the printer has a caster base, then carefully roll it to the new location. Use caution when passing over thresholds and breaks in flooring.
- If the printer does not have a caster base but is configured with optional trays or output options, then remove the output options and lift the printer off the trays. Do not try to lift the printer and any options at the same time.
- Always use the handholds on the printer to lift it.
- Any cart used to move the printer must have a surface able to support the full footprint of the printer.
- Any cart used to move the hardware options must have a surface able to support the dimensions of the options.
- Keep the printer in an upright position.
- Avoid severe jarring movements.
- Make sure that your fingers are not under the printer when you set it down.
- Make sure that there is adequate clearance around the printer.

Note: Damage to the printer caused by improper moving is not covered by the printer warranty.

Shipping the printer

For shipping instructions, go to <http://support.lexmark.com> or contact customer support.

Troubleshoot a problem

Print quality problems

Find the image that resembles the print quality problem you are having, and then click the link below it to read problem-solving steps.

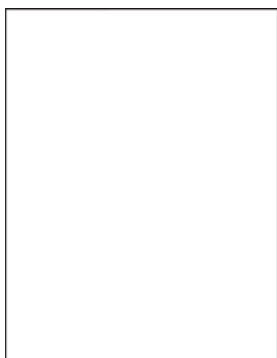

[“Blank or white pages” on page 90](#)



[“Dark print” on page 91](#)



[“Fine lines are not printed correctly” on page 93](#)



[“Folded or wrinkled paper” on page 94](#)



[“Gray background” on page 95](#)



[“Horizontal light bands” on page 105](#)



[“Incorrect margins” on page 97](#)



[“Light print” on page 97](#)



[“Mottled print and dots” on page 99](#)



[“Paper curl” on page 100](#)



[“Print crooked or skewed” on page 102](#)



[“Repeating defects” on page 111](#)

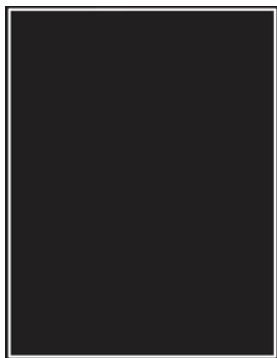

[“Solid black pages” on page 103](#)



[“Text or images cut off” on page 104](#)



[“Toner easily rubs off” on page 105](#)



[“Vertical dark bands” on page 108](#)



[“Vertical dark lines or streaks” on page 109](#)

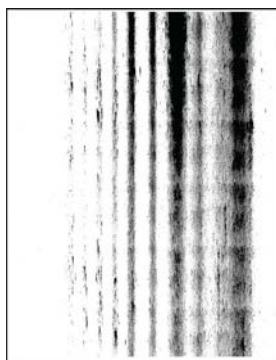

[“Vertical dark streaks with print missing” on page 110](#)



[“Vertical light bands” on page 106](#)



[“Vertical white lines” on page 107](#)

Printing problems

Print quality is poor

Blank or white pages

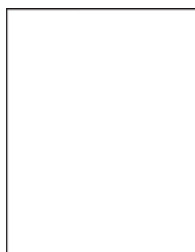

Note: Before solving the problem, print the Print Quality Test Pages. From the control panel, navigate to **Settings > Troubleshooting > Print Quality Test Pages**. For non-touch-screen printer models, press **OK** to navigate through the settings.

Action	Yes	No
<p>Step 1</p> <p>a Check if the printer is using a genuine and supported Lexmark toner cartridge.</p> <p>Note: If the cartridge is not supported, then install a supported one.</p> <p>b Print the document.</p> <p>Is the printer printing blank or white pages?</p>	Go to step 2.	The problem is solved.
<p>Step 2</p> <p>a Remove the imaging unit.</p> <p>Warning—Potential Damage: Do not expose the imaging unit to direct light for more than 10 minutes. Extended exposure to light may cause print quality problems.</p> <p>Warning—Potential Damage: Do not touch the photoconductor drum under the imaging unit. Doing so may affect the quality of future print jobs.</p> <p>b Check the imaging unit for signs of damage.</p> <p>Note: Make sure that the photoconductor drum contact is not bent or out of place.</p> <p>c Firmly shake the imaging unit to redistribute the toner.</p> <p>d Insert the imaging unit.</p> <p>e Print the document.</p> <p>Is the printer printing blank or white pages?</p>	Go to step 3.	The problem is solved.
<p>Step 3</p> <p>Replace the toner cartridge.</p> <p>Is the printer printing blank or white pages?</p>	Go to step 4.	The problem is solved.
<p>Step 4</p> <p>Replace the imaging unit.</p> <p>Is the printer printing blank or white pages?</p>	Contact customer support .	The problem is solved.

Dark print



Note: Before solving the problem, print the Print Quality Test Pages. From the control panel, navigate to **Settings > Troubleshooting > Print Quality Test Pages**. For non-touch-screen printer models, press **OK** to navigate through the settings.

Action	Yes	No
<p>Step 1</p> <p>a Check if the printer is using a genuine and supported Lexmark toner cartridge.</p> <p>Note: If the cartridge is not supported, then install a supported one.</p> <p>b Print the document.</p> <p>Is the print dark?</p>	Go to step 2.	The problem is solved.
<p>Step 2</p> <p>a Turn off the printer, wait for about 10 seconds, and then turn on the printer.</p> <p>b Reduce toner darkness.</p> <p>From the control panel, navigate to: Settings > Print > Quality > Toner Darkness</p> <p>c Print the document.</p> <p>Is the print dark?</p>	Go to step 3.	The problem is solved.
<p>Step 3</p> <p>a Depending on your operating system, specify the paper type from the Printing Preferences or Print dialog.</p> <p>Notes:</p> <ul style="list-style-type: none"> • Make sure that the setting matches the paper loaded. • You can also change the setting on the printer control panel. Navigate to Settings > Paper > Tray Configuration > Paper Size/Type. <p>b Print the document.</p> <p>Is the print dark?</p>	Go to step 4.	The problem is solved.
<p>Step 4</p> <p>Check if the paper has texture or rough finishes.</p> <p>Are you printing on textured or rough paper?</p>	Go to step 5.	Go to step 6.
<p>Step 5</p> <p>a Replace textured paper with plain paper.</p> <p>b Print the document.</p> <p>Is the print dark?</p>	Go to step 6.	The problem is solved.

Action	Yes	No
<p>Step 6</p> <p>a Load paper from a fresh package.</p> <p>Note: Paper absorbs moisture due to high humidity. Store paper in its original wrapper until you are ready to use it.</p> <p>b Print the document.</p> <p>Is the print dark?</p>	Go to step 7.	The problem is solved.
<p>Step 7</p> <p>a Remove, and then insert the imaging unit.</p> <p>Warning—Potential Damage: Do not expose the imaging unit to direct light for more than 10 minutes. Extended exposure to light may cause print quality problems.</p> <p>Warning—Potential Damage: Do not touch the photoconductor drum under the imaging unit. Doing so may affect the quality of future print jobs.</p> <p>b Print the document.</p> <p>Is the print dark?</p>	Go to step 8.	The problem is solved.
<p>Step 8</p> <p>a Replace the imaging unit.</p> <p>b Print the document.</p> <p>Is the print dark?</p>	Contact customer support .	The problem is solved.

Fine lines are not printed correctly



Note: Before solving the problem, print the Print Quality Test Pages. From the control panel, navigate to **Settings > Troubleshooting > Print Quality Test Pages**. For non-touch-screen printer models, press **OK** to navigate through the settings.

Action	Yes	No
<p>Step 1</p> <p>a Check if the printer is using a genuine and supported Lexmark toner cartridge.</p> <p>Note: If the cartridge is not supported, then install a supported one.</p> <p>b Print the document.</p> <p>Are fine lines not printed correctly?</p>	Go to step 2.	The problem is solved.
<p>Step 2</p> <p>a Increase toner darkness.</p> <p>From the control panel, navigate to: Settings > Print > Quality > Toner Darkness</p> <p>b Print the document.</p> <p>Are fine lines not printed correctly?</p>	Contact customer support .	The problem is solved.

Folded or wrinkled paper



Note: Before solving the problem, print the Print Quality Test Pages. From the control panel, navigate to **Settings > Troubleshooting > Print Quality Test Pages**. For non-touch-screen printer models, press **OK** to navigate through the settings.

Action	Yes	No
<p>Step 1</p> <p>a Check if the printer is using a genuine and supported Lexmark toner cartridge.</p> <p>Note: If the cartridge is not supported, then install a supported one.</p> <p>b Print the document.</p> <p>Is the paper folded or wrinkled?</p>	Go to step 2.	The problem is solved.

Action	Yes	No
<p>Step 2</p> <p>a Load paper from a fresh package.</p> <p>Note: Paper absorbs moisture due to high humidity. Store paper in its original wrapper until you are ready to use it.</p> <p>b Print the document.</p> <p>Is the paper folded or wrinkled?</p>	Go to step 3.	The problem is solved.
<p>Step 3</p> <p>a Depending on your operating system, specify the paper type from the Printing Preferences or Print dialog.</p> <p>Notes:</p> <ul style="list-style-type: none"> • Make sure that the setting matches the paper loaded. • You can also change the setting from the printer control panel. Navigate to Settings > Paper > Tray Configuration > Paper Size/Type. <p>b Print the document.</p> <p>Is the paper folded or wrinkled?</p>	Contact customer support .	The problem is solved.

Gray background



Note: Before solving the problem, print the Print Quality Test Pages. From the control panel, navigate to **Settings > Troubleshooting > Print Quality Test Pages**. For non-touch-screen printer models, press **OK** to navigate through the settings.

Action	Yes	No
<p>Step 1</p> <p>a Turn off the printer, wait for 10 seconds, and then turn on the printer.</p> <p>b Decrease toner darkness.</p> <p>From the control panel, navigate to:</p> <p>Settings > Print > Quality > Toner Darkness</p> <p>c Print the document.</p> <p>Does gray background appear on prints?</p>	Go to step 2.	The problem is solved.

Action	Yes	No
<p>Step 2</p> <p>a Check if the printer is using a genuine and supported Lexmark toner cartridge.</p> <p>Note: If the toner cartridge is not supported, then install a supported one.</p> <p>b Print the document.</p> <p>Does gray background appear on prints?</p>	<p>Go to step 3.</p>	<p>The problem is solved.</p>
<p>Step 3</p> <p>a Depending on your operating system, specify the paper type from the Printing Preferences or Print dialog.</p> <p>Notes:</p> <ul style="list-style-type: none"> • Make sure that the setting matches the paper loaded. • You can also change the setting from the printer control panel. Navigate to Settings > Paper > Tray Configuration > Paper Size/Type. <p>b Print the document.</p> <p>Does gray background appear on prints?</p>	<p>Go to step 4.</p>	<p>The problem is solved.</p>
<p>Step 4</p> <p>a Remove, and then insert the imaging unit.</p> <p>Warning—Potential Damage: Do not expose the imaging unit to direct light for more than 10 minutes. Extended exposure to light may cause print quality problems.</p> <p>Warning—Potential Damage: Do not touch the photoconductor drum under the imaging unit. Doing so may affect the quality of future print jobs.</p> <p>b Print the document.</p> <p>Does gray background appear on prints?</p>	<p>Go to step 5.</p>	<p>The problem is solved.</p>
<p>Step 5</p> <p>a Update the printer firmware. For more information, see “Updating firmware” on page 25.</p> <p>b Print the document.</p> <p>Does gray background appear on prints?</p>	<p>Go to step 6.</p>	<p>The problem is solved.</p>
<p>Step 6</p> <p>a Replace the imaging unit.</p> <p>b Print the document.</p> <p>Does gray background appear on prints?</p>	<p>Contact customer support.</p>	<p>The problem is solved.</p>

Incorrect margins



Action	Yes	No
<p>Step 1</p> <p>a Adjust the paper guides to the correct position for the paper loaded.</p> <p>b Print the document.</p> <p>Are the margins correct?</p>	The problem is solved.	Go to step 2.
<p>Step 2</p> <p>a Set the paper size. From the control panel, navigate to: Settings > Paper > Tray Configuration > Paper Size/Type</p> <p>b Print the document.</p> <p>Are the margins correct?</p>	The problem is solved.	Go to step 3.
<p>Step 3</p> <p>a Depending on your operating system, specify the paper size from the Printing Preferences or Print dialog. Note: Make sure that the setting matches the paper loaded.</p> <p>b Print the document.</p> <p>Are the margins correct?</p>	The problem is solved.	Contact customer support .

Light print



Note: Before solving the problem, print the Print Quality Test Pages. From the control panel, navigate to **Settings > Troubleshooting > Print Quality Test Pages**. For non-touch-screen printer models, press **OK** to navigate through the settings.

Action	Yes	No
<p>Step 1</p> <p>a Check if the printer is using a genuine and supported Lexmark toner cartridge.</p> <p>Note: If the cartridge is not supported, then install a supported one.</p> <p>b Print the document.</p> <p>Is the print light?</p>	<p>Go to step 2.</p>	<p>The problem is solved.</p>
<p>Step 2</p> <p>a Turn off the printer, wait for about 10 seconds, and then turn on the printer.</p> <p>b Increase toner darkness. From the control panel, navigate to: Settings > Print > Quality > Toner Darkness</p> <p>c Print the document.</p> <p>Is the print light?</p>	<p>Go to step 3.</p>	<p>The problem is solved.</p>
<p>Step 3</p> <p>a Depending on your operating system, specify the paper type from the Printing Preferences or Print dialog.</p> <p>Notes:</p> <ul style="list-style-type: none"> • Make sure that the setting matches the paper loaded. • You can also change the setting on the printer control panel. Navigate to Settings > Paper > Tray Configuration > Paper Size/Type. <p>b Print the document.</p> <p>Is the print light?</p>	<p>Go to step 4.</p>	<p>The problem is solved.</p>
<p>Step 4</p> <p>a Depending on your operating system, specify the print resolution from the Printing Preferences or Print dialog.</p> <p>b Set the resolution to 600 dpi.</p> <p>c Print the document.</p> <p>Is the print light?</p>	<p>Go to step 5.</p>	<p>The problem is solved.</p>

Action	Yes	No
<p>Step 5</p> <p>a Remove the imaging unit.</p> <p>Warning—Potential Damage: Do not expose the imaging unit to direct light for more than 10 minutes. Extended exposure to light can cause print quality problems.</p> <p>Warning—Potential Damage: Do not touch the photoconductor drum under the imaging unit. Doing so may affect the quality of future print jobs.</p> <p>b Firmly shake the imaging unit to redistribute the toner.</p> <p>c Insert the imaging unit.</p> <p>d Turn off the printer, wait for 10 seconds, and then turn on the printer.</p> <p>e Print the document.</p> <p>Is the print light?</p>	Go to step 6.	The problem is solved.
<p>Step 6</p> <p>a Check the status of the toner cartridge.</p> <p>From the control panel, navigate to:</p> <p>Settings > Reports > Device > Device Statistics</p> <p>b From the Supply Information section of the pages printed, check the status of the toner cartridge.</p> <p>Is the toner cartridge near end of life?</p>	Go to step 7.	Contact customer support .
<p>Step 7</p> <p>a Replace the toner cartridge.</p> <p>b Print the document.</p> <p>Is the print light?</p>	Contact customer support .	The problem is solved.

Mottled print and dots



Note: Before solving the problem, print the Print Quality Test Pages. From the control panel, navigate to **Settings > Troubleshooting > Print Quality Test Pages**. For non-touch-screen printer models, press **OK** to navigate through the settings.

Action	Yes	No
<p>Step 1</p> <p>a Check if the printer is using a genuine and supported Lexmark toner cartridge.</p> <p>Note: If the cartridge is not supported, then install a supported one.</p> <p>b Print the document.</p> <p>Is the print mottled?</p>	Go to step 2.	The problem is solved.
<p>Step 2</p> <p>Check the printer for leaked toner contamination.</p> <p>Is the printer free of leaked toner?</p>	Go to step 3.	Contact customer support .
<p>Step 3</p> <p>a Check the status of the imaging unit.</p> <p>From the control panel, navigate to:</p> <p>Settings > Reports > Device > Device Statistics</p> <p>b From the Supply Information section of the pages printed, check the status of the imaging unit.</p> <p>Is the imaging unit near end of life?</p>	Go to step 4.	Contact customer support .
<p>Step 4</p> <p>a Replace the imaging unit.</p> <p>b Print the document.</p> <p>Is the print mottled?</p>	Contact customer support .	The problem is solved.

Paper curl



Note: Before solving the problem, print the Print Quality Test Pages. From the control panel, navigate to **Settings > Troubleshooting > Print Quality Test Pages**. For non-touch-screen printer models, press **OK** to navigate through the settings.

Action	Yes	No
<p>Step 1</p> <p>a Check if the paper loaded is supported. Note: If paper is not supported, then load a supported paper.</p> <p>b Print the document.</p> <p>Is the paper curled?</p>	Go to step 2.	The problem is solved.
<p>Step 2</p> <p>a Check if the printer is using a genuine and supported Lexmark toner cartridge. Note: If the cartridge is not supported, then install a supported one.</p> <p>b Print the document.</p> <p>Is the paper curled?</p>	Go to step 3.	The problem is solved.
<p>Step 3</p> <p>a Adjust the guides in the tray to the correct position for the paper loaded.</p> <p>b Print the document.</p> <p>Is the paper curled?</p>	Go to step 4.	The problem is solved.
<p>Step 4</p> <p>a Depending on your operating system, specify the paper size and paper type from the Printing Preferences or Print dialog. Notes:</p> <ul style="list-style-type: none"> • Make sure that the settings match the paper loaded. • You can also change the setting on the printer control panel. Navigate to Settings > Paper > Tray Configuration > Paper Size/Type. <p>b Print the document.</p> <p>Is the paper curled?</p>	Go to step 5.	The problem is solved.
<p>Step 5</p> <p>a Remove paper, flip it over, and then reload paper.</p> <p>b Print the document.</p> <p>Is the paper curled?</p>	Go to step 6.	The problem is solved.
<p>Step 6</p> <p>a Load paper from a fresh package. Note: Paper absorbs moisture due to high humidity. Store paper in its original wrapper until you are ready to use it.</p> <p>b Print the document.</p> <p>Is the paper curled?</p>	Contact customer support .	The problem is solved.

Print crooked or skewed



Note: Before solving the problem, print the Print Quality Test Pages. From the control panel, navigate to **Settings > Troubleshooting > Print Quality Test Pages**. For non-touch-screen printer models, press **OK** to navigate through the settings.

Action	Yes	No
<p>Step 1</p> <p>a Adjust the guides in the tray to the correct position for the paper loaded.</p> <p>b Print the document.</p> <p>Is the print crooked or skewed?</p>	Go to step 2.	The problem is solved.
<p>Step 2</p> <p>a Load paper from a fresh package.</p> <p>Note: Paper absorbs moisture due to high humidity. Store paper in its original wrapper until you are ready to use it.</p> <p>b Print the document.</p> <p>Is the print crooked or skewed?</p>	Go to step 3.	The problem is solved.
<p>Step 3</p> <p>a Check if the paper loaded is supported.</p> <p>Note: If paper is not supported, then load a supported paper.</p> <p>b Print the document.</p> <p>Is the print crooked or skewed?</p>	Contact customer support .	The problem is solved.
<p>Step 4</p> <p>a For two-sided printing, check if the paper size setting in the duplex unit is set correctly.</p> <p>Note: Letter, legal, Oficio, or folio must be set to Letter.</p> <p>b Print the document.</p> <p>Is the print crooked or skewed?</p>	Contact customer support .	The problem is solved.

Solid black pages

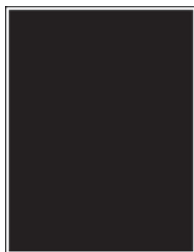

Note: Before solving the problem, print the Print Quality Test Pages. From the control panel, navigate to **Settings > Troubleshooting > Print Quality Test Pages**. For non-touch-screen printer models, press **OK** to navigate through the settings.

Action	Yes	No
<p>Step 1</p> <p>a Check if the printer is using a genuine and supported Lexmark toner cartridge.</p> <p>Note: If the toner cartridge is not supported, then install a supported one.</p> <p>b Print the document.</p> <p>Is the printer printing solid black pages?</p>	Go to step 2.	The problem is solved.
<p>Step 2</p> <p>a Remove, and then insert the imaging unit.</p> <p>Warning—Potential Damage: Do not expose the imaging unit to direct light for more than 10 minutes. Extended exposure to light may cause print quality problems.</p> <p>Warning—Potential Damage: Do not touch the photoconductor drum under the imaging unit. Doing so may affect the quality of future print jobs.</p> <p>b Print the document.</p> <p>Is the printer printing solid black pages?</p>	Go to step 3.	The problem is solved.
<p>Step 3</p> <p>Check the imaging unit for signs of damage.</p> <p>Note: Make sure that the photoconductor drum contact is not bent or out of place.</p> <p>Is the imaging unit free from damage?</p>	Contact customer support .	Go to step 4.
<p>Step 4</p> <p>a Replace the imaging unit.</p> <p>b Print the document.</p> <p>Is the printer printing solid black pages?</p>	Contact customer support .	The problem is solved.

Text or images cut off



Note: Before solving the problem, print the Print Quality Test Pages. From the control panel, navigate to **Settings > Troubleshooting > Print Quality Test Pages**. For non-touch-screen printer models, press **OK** to navigate through the settings.

Action	Yes	No
<p>Step 1</p> <p>a Check if the printer is using a genuine and supported Lexmark toner cartridge.</p> <p>Note: If the toner cartridge is not supported, then install a supported one.</p> <p>b Print the document.</p> <p>Are text or images cut off?</p>	Go to step 2.	The problem is solved.
<p>Step 2</p> <p>a Remove, and then insert the imaging unit.</p> <p>Warning—Potential Damage: Do not expose the imaging unit to direct light for more than 10 minutes. Extended exposure to light may cause print quality problems.</p> <p>Warning—Potential Damage: Do not touch the photoconductor drum under the imaging unit. Doing so may affect the quality of future print jobs.</p> <p>b Print the document.</p> <p>Are text or images cut off?</p>	Go to step 3.	The problem is solved.
<p>Step 3</p> <p>a Replace the imaging unit.</p> <p>b Print the document.</p> <p>Are text or images cut off?</p>	Contact customer support .	The problem is solved.

Toner easily rubs off



Note: Before solving the problem, print the Print Quality Test Pages. From the control panel, navigate to **Settings > Troubleshooting > Print Quality Test Pages**. For non-touch-screen printer models, press **OK** to navigate through the settings.

Action	Yes	No
<p>Step 1</p> <p>a Check if the printer is using a genuine and supported Lexmark toner cartridge.</p> <p>Note: If the toner cartridge is not supported, then install a supported one.</p> <p>b Print the document.</p> <p>Does toner easily rub off?</p>	<p>Go to step 2.</p>	<p>The problem is solved.</p>
<p>Step 2</p> <p>a Depending on your operating system, specify the paper type from the Printing Preferences or Print dialog.</p> <p>Notes:</p> <ul style="list-style-type: none"> • Make sure that the setting matches the paper loaded. • You can also change the setting on the printer control panel. Navigate to Settings > Paper > Tray Configuration > Paper Size/Type. <p>b Print the document.</p> <p>Does toner easily rub off?</p>	<p>Contact customer support.</p>	<p>The problem is solved.</p>

Horizontal light bands



Note: Before solving the problem, print the Print Quality Test Pages. From the control panel, navigate to **Settings > Troubleshooting > Print Quality Test Pages**. For non-touch-screen printer models, press **OK** to navigate through the settings.

Action	Yes	No
<p>Step 1</p> <p>a Check if the printer is using a genuine and supported Lexmark toner cartridge.</p> <p>Note: If the cartridge is not supported, then install a supported one.</p> <p>b Print the document.</p> <p>Do horizontal light bands appear on prints?</p>	Go to step 2.	The problem is solved.
<p>Step 2</p> <p>a Remove, and then insert the imaging unit.</p> <p>Warning—Potential Damage: Do not expose the imaging unit to direct light for more than 10 minutes. Extended exposure to light may cause print quality problems.</p> <p>Warning—Potential Damage: Do not touch the photoconductor drum under the imaging unit. Doing so may affect the quality of future print jobs.</p> <p>b Print the document.</p> <p>Do horizontal light bands appear on prints?</p>	Go to step 3.	The problem is solved.
<p>Step 3</p> <p>a Replace the imaging unit.</p> <p>b Print the document.</p> <p>Do horizontal light bands appear on prints?</p>	Contact customer support .	The problem is solved.

Vertical light bands



Note: Before solving the problem, print the Print Quality Test Pages. From the control panel, navigate to **Settings > Troubleshooting > Print Quality Test Pages**. For non-touch-screen printer models, press **OK** to navigate through the settings.

Action	Yes	No
<p>Step 1</p> <p>a Check if the printer is using a genuine and supported Lexmark toner cartridge.</p> <p>Note: If the cartridge is not supported, then install a supported one.</p> <p>b Print the document.</p> <p>Do vertical light bands appear on prints?</p>	Go to step 2.	The problem is solved.
<p>Step 2</p> <p>a Check the status of the toner cartridge. From the control panel, navigate to: Settings > Reports > Device > Device Statistics</p> <p>b From the Supply Information section of the pages printed, check the status of the toner cartridge.</p> <p>Do vertical light bands appear on prints?</p>	Go to step 3.	The problem is solved.
<p>Step 3</p> <p>a Replace the toner cartridge.</p> <p>b Print the document.</p> <p>Do vertical light bands appear on prints?</p>	Contact customer support .	The problem is solved.

Vertical white lines



Note: Before solving the problem, print the Print Quality Test Pages. From the control panel, navigate to **Settings > Troubleshooting > Print Quality Test Pages**. For non-touch-screen printer models, press **OK** to navigate through the settings.

Action	Yes	No
<p>Step 1</p> <p>a Check if the printer is using a genuine and supported Lexmark toner cartridge.</p> <p>Note: If the cartridge is not supported, then install a supported one.</p> <p>b Print the document.</p> <p>Do vertical white lines appear on prints?</p>	Go to step 2.	The problem is solved.
<p>Step 2</p> <p>a Depending on your operating system, specify the paper type from the Printing Preferences or Print dialog.</p> <p>Notes:</p> <ul style="list-style-type: none"> • Make sure that the setting matches the paper loaded. • You can also change the setting on the printer control panel. Navigate to Settings > Paper > Tray Configuration > Paper Size/Type. <p>b Print the document.</p> <p>Do vertical white lines appear on prints?</p>	Contact customer support .	The problem is solved.

Vertical dark bands



Note: Before solving the problem, print the Print Quality Test Pages. From the control panel, navigate to **Settings > Troubleshooting > Print Quality Test Pages**. For non-touch-screen printer models, press **OK** to navigate through the settings.

Action	Yes	No
<p>Step 1</p> <p>a Check if the printer is using a genuine and supported Lexmark toner cartridge.</p> <p>Note: If the toner cartridge is not supported, then install a supported one.</p> <p>b Print the document.</p> <p>Do vertical dark bands appear on prints?</p>	Go to step 2.	The problem is solved.

Action	Yes	No
<p>Step 2</p> <p>a Remove, and then insert the imaging unit.</p> <p>Warning—Potential Damage: Do not expose the imaging unit to direct light for more than 10 minutes. Extended exposure to light may cause print quality problems.</p> <p>Warning—Potential Damage: Do not touch the photoconductor drum under the imaging unit. Doing so may affect the quality of future print jobs.</p> <p>b Print the document.</p> <p>Do vertical dark bands appear on prints?</p>	Go to step 3.	The problem is solved.
<p>Step 3</p> <p>a Check if a bright light enters the right side of the printer, and move the printer if necessary.</p> <p>b Print the document.</p> <p>Do vertical dark bands appear on prints?</p>	Contact customer support .	The problem is solved.

Vertical dark lines or streaks



Note: Before solving the problem, print the Print Quality Test Pages. From the control panel, navigate to **Settings > Troubleshooting > Print Quality Test Pages**. For non-touch-screen printer models, press **OK** to navigate through the settings.

Action	Yes	No
<p>Step 1</p> <p>a Check if the printer is using a genuine and supported Lexmark toner cartridge.</p> <p>Note: If the toner cartridge is not supported, then install a supported one.</p> <p>b Print the document.</p> <p>Do vertical dark lines or streaks appear on prints?</p>	Go to step 2.	The problem is solved.

Action	Yes	No
<p>Step 2</p> <p>a Remove, and then reinstall the imaging unit.</p> <p>Warning—Potential Damage: Do not expose the imaging unit to direct light for more than 10 minutes. Extended exposure to light can cause print quality problems.</p> <p>Warning—Potential Damage: Do not touch the photoconductor drum under the imaging unit. Doing so may affect the quality of future print jobs.</p> <p>b Print the document.</p> <p>Do vertical dark lines or streaks appear on prints?</p>	Go to step 3.	The problem is solved.
<p>Step 3</p> <p>a Replace the imaging unit.</p> <p>b Print the document.</p> <p>Do vertical dark lines or streaks appear on prints?</p>	Contact customer support .	The problem is solved.

Vertical dark streaks with print missing



Note: Before solving the problem, print the Print Quality Test Pages. From the control panel, navigate to **Settings > Troubleshooting > Print Quality Test Pages**. For non-touch-screen printer models, press **OK** to navigate through the settings.

Action	Yes	No
<p>Step 1</p> <p>a Remove, and then insert the imaging unit.</p> <p>Warning—Potential Damage: Do not expose the imaging unit to direct light for more than 10 minutes. Extended exposure to light may cause print quality problems.</p> <p>Warning—Potential Damage: Do not touch the photoconductor drum under the imaging unit. Doing so may affect the quality of future print jobs.</p> <p>b Print the document.</p> <p>Do vertical dark streaks with missing images appear on prints?</p>	Go to step 2.	The problem is solved.

Action	Yes	No
<p>Step 2</p> <p>a Check if the printer is using a genuine and supported Lexmark toner cartridge.</p> <p>Note: If the toner cartridge is not supported, then install a supported one.</p> <p>b Print the document.</p> <p>Do vertical dark streaks with missing images appear on prints?</p>	<p>Contact customer support.</p>	<p>The problem is solved.</p>

Repeating defects



Note: Before solving the problem, print the Print Quality Test Pages. From the control panel, navigate to **Settings > Troubleshooting > Print Quality Test Pages**. For non-touch-screen printer models, press **OK** to navigate through the settings.

Action	Yes	No
<p>Step 1</p> <p>Using the Print Quality Test Pages, check if the distance between the repeating defects is equal to any of the following:</p> <p>Imaging unit</p> <ul style="list-style-type: none"> • 96 mm (3.78 in.) • 37.7 mm (1.48 in.) <p>Toner cartridge</p> <ul style="list-style-type: none"> • 43.5 mm (1.71 in.) • 37.5 mm (1.48 in.) <p>Transfer roller</p> <ul style="list-style-type: none"> • 52 mm (2.05 in.) <p>Fuser</p> <ul style="list-style-type: none"> • 79.8 mm (3.14 in.) • 62.5 mm (2.46 in.) <p>Does the distance between the repeating defects match the toner cartridge or imaging unit measurements?</p>	<p>Go to step 2.</p> <p>Note: If the repeating defects match the transfer roller or fuser measurements, then contact customer support.</p>	<p>Take note of the distance, and then contact customer support.</p>

Action	Yes	No
<p>Step 2</p> <p>a Replace the affected supply item.</p> <p>b Print the document.</p> <p>Do the repeating defects appear?</p>	<p>Contact customer support.</p>	<p>The problem is solved.</p>

Print jobs do not print

Action	Yes	No
<p>Step 1</p> <p>a From the document you are trying to print, open the Print dialog, and then check if you have selected the correct printer.</p> <p>b Print the document.</p> <p>Is the document printed?</p>	<p>The problem is solved.</p>	<p>Go to step 2.</p>
<p>Step 2</p> <p>a Check if the printer is on.</p> <p>b Resolve any error messages that appear on the display.</p> <p>c Print the document.</p> <p>Is the document printed?</p>	<p>The problem is solved.</p>	<p>Go to step 3.</p>
<p>Step 3</p> <p>a Check if the ports are working and if the cables are securely connected to the computer and the printer.</p> <p>For more information, see the setup documentation that came with the printer.</p> <p>b Print the document.</p> <p>Is the document printed?</p>	<p>The problem is solved.</p>	<p>Go to step 4.</p>
<p>Step 4</p> <p>a Turn off the printer, wait for about 10 seconds, and then turn on the printer.</p> <p>b Print the document.</p> <p>Is the document printed?</p>	<p>The problem is solved.</p>	<p>Go to step 5.</p>
<p>Step 5</p> <p>a Remove, and then reinstall the print driver.</p> <p>b Print the document.</p> <p>Is the document printed?</p>	<p>The problem is solved.</p>	<p>Contact customer support.</p>

Slow printing

Action	Yes	No
<p>Step 1</p> <p>Make sure that the printer cable is securely connected to the printer and to the computer, print server, option, or other network device.</p> <p>Is the printer printing slow?</p>	Go to step 2.	The problem is solved.
<p>Step 2</p> <p>a Make sure that the printer is not in Quiet Mode. From the control panel, navigate to: Settings > OK > Device > OK > Maintenance > OK > Config Menu > OK > Device Operations > OK > Quiet Mode > OK</p> <p>b Print the document.</p> <p>Is the printer printing slow?</p>	Go to step 3.	The problem is solved.
<p>Step 3</p> <p>a Depending on your operating system, specify the print resolution from the Printing Preferences or Print dialog.</p> <p>b Set the resolution to 600 dpi.</p> <p>c Print the document.</p> <p>Is the printer printing slow?</p>	Go to step 4.	The problem is solved.
<p>Step 4</p> <p>a From the control panel, navigate to: Settings > OK > Print > OK > Quality > OK > Print Resolution > OK</p> <p>b Set the resolution to 600 dpi.</p> <p>c Print the document.</p> <p>Is the printer printing slow?</p>	Go to step 5.	The problem is solved.
<p>Step 5</p> <p>a Depending on your operating system, specify the paper type from the Printing Preferences or Print dialog.</p> <p>Notes:</p> <ul style="list-style-type: none"> • Make sure that the setting matches the paper loaded. • Heavier paper prints more slowly. • Paper narrower than letter, A4, and legal may print more slowly. <p>b Print the document.</p> <p>Is the printer printing slow?</p>	Go to step 6.	The problem is solved.

Action	Yes	No
<p>Step 6</p> <p>a Make sure that the printer settings for texture and weight match the paper being loaded.</p> <p>From the control panel, navigate to:</p> <p>Settings > OK > Paper > OK > Media Configuration > OK > Media Types > OK</p> <p>Note: Rough paper textures and heavy paper weights may print more slowly.</p> <p>b Print the document.</p> <p>Is the printer printing slow?</p>	Go to step 7.	The problem is solved.
<p>Step 7</p> <p>Remove held jobs.</p> <p>Is the printer printing slow?</p>	Go to step 8.	The problem is solved.
<p>Step 8</p> <p>a Make sure that the printer is not overheating.</p> <p>Notes:</p> <ul style="list-style-type: none"> • Allow the printer to cool down after a long print job. • Observe the recommended ambient temperature for the printer. For more information, see “Selecting a location for the printer” on page 18. <p>b Print the document.</p> <p>Is the printer printing slow?</p>	Contact customer support .	The problem is solved.

Job prints from the wrong tray or on the wrong paper

Action	Yes	No
<p>Step 1</p> <p>a Check if you are printing on the correct paper.</p> <p>b Print the document.</p> <p>Is the document printed on the correct paper?</p>	Go to step 2.	Load the correct paper size and paper type.

Action	Yes	No
<p>Step 2</p> <p>a Depending on your operating system, specify the paper size and paper type from the Printing Preferences or Print dialog.</p> <p>Note: You can also change the settings on the printer control panel. Navigate to:</p> <p>Settings > OK > Paper > OK > Tray Configuration > OK > Paper Size/Type > OK</p> <p>b Make sure that the settings match the paper loaded.</p> <p>c Print the document.</p> <p>Is the document printed on the correct paper?</p>	<p>The problem is solved.</p>	<p>Go to step 3.</p>
<p>Step 3</p> <p>a Check if the trays are linked.</p> <p>For more information, see “Linking trays” on page 23.</p> <p>b Print the document.</p> <p>Is the document printed from the correct tray?</p>	<p>The problem is solved.</p>	<p>Contact customer support.</p>

Confidential and other held documents do not print

Action	Yes	No
<p>Step 1</p> <p>a From the control panel, check if the documents appear in the Held Jobs list.</p> <p>Note: If the documents are not listed, then print the documents using the Print and Hold options.</p> <p>b Print the documents.</p> <p>Are the documents printed?</p>	<p>The problem is solved.</p>	<p>Go to step 2.</p>
<p>Step 2</p> <p>The print job may contain a formatting error or invalid data.</p> <ul style="list-style-type: none"> • Delete the print job, and then send it again. • For PDF files, generate a new file, and then print the documents. <p>Are the documents printed?</p>	<p>The problem is solved.</p>	<p>Go to step 3.</p>

Action	Yes	No
<p>Step 3</p> <p>If you are printing from the Internet, then the printer may be reading the multiple job titles as duplicates.</p> <p>For Windows users</p> <ul style="list-style-type: none"> a Open the Printing Preferences dialog. b From the Print and Hold tab, click Use Print and Hold, and then click Keep duplicate documents. c From the Confidential Print section, enter a PIN. d Print the documents. <p>For Macintosh users</p> <ul style="list-style-type: none"> a Save and name each job differently. b Send the job individually. <p>Are the documents printed?</p>	<p>The problem is solved.</p>	<p>Go to step 4.</p>
<p>Step 4</p> <ul style="list-style-type: none"> a Delete some held jobs to free up printer memory. b Print the documents. <p>Are the documents printed?</p>	<p>The problem is solved.</p>	<p>Contact customer support.</p>

The printer is not responding

Action	Yes	No
<p>Step 1</p> <p>Check if the power cord is connected to the electrical outlet.</p> <p> CAUTION—POTENTIAL INJURY: To avoid the risk of fire or electrical shock, connect the power cord to an appropriately rated and properly grounded electrical outlet that is near the product and easily accessible.</p> <p>Is the printer responding?</p>	<p>The problem is solved.</p>	<p>Go to step 2.</p>
<p>Step 2</p> <p>Check if the electrical outlet is turned off by a switch or breaker.</p> <p>Is the electrical outlet turned off by a switch or breaker?</p>	<p>Turn on the switch or reset the breaker.</p>	<p>Go to step 3.</p>
<p>Step 3</p> <p>Check if the printer is on.</p> <p>Is the printer on?</p>	<p>Go to step 4.</p>	<p>Turn on the printer.</p>

Action	Yes	No
<p>Step 4 Check if the printer is in Sleep or Hibernate mode.</p> <p>Is the printer in Sleep or Hibernate mode?</p>	<p>Press the power button to wake the printer.</p>	<p>Go to step 5.</p>
<p>Step 5 Check if the cables connecting the printer and the computer are inserted to the correct ports.</p> <p>Are the cables inserted to the correct ports?</p>	<p>Go to step 6.</p>	<p>Insert the cables to the correct ports.</p>
<p>Step 6 Turn off the printer, install the hardware options, and then turn on the printer. For more information, see the documentation that came with the option.</p> <p>Is the printer responding?</p>	<p>The problem is solved.</p>	<p>Go to step 7.</p>
<p>Step 7 Install the correct print driver.</p> <p>Is the printer responding?</p>	<p>The problem is solved.</p>	<p>Go to step 8.</p>
<p>Step 8 Turn off the printer, wait for about 10 seconds, and then turn on the printer.</p> <p>Is the printer responding?</p>	<p>The problem is solved.</p>	<p>Contact customer support.</p>

Network connection problems

Cannot open Embedded Web Server

Action	Yes	No
<p>Step 1 Check if the printer is on.</p> <p>Is the printer on?</p>	Go to step 2.	Turn on the printer.
<p>Step 2 Make sure that the printer IP address is correct.</p> <p>Notes:</p> <ul style="list-style-type: none"> • View the IP address on the home screen. • An IP address appears as four sets of numbers separated by periods, such as 123.123.123.123. <p>Is the printer IP address correct?</p>	Go to step 3.	Type the correct printer IP address in the address field.
<p>Step 3 Check if you are using a supported browser:</p> <ul style="list-style-type: none"> • Internet Explorer version 11 or later • Microsoft Edge • Safari version 6 or later • Google Chrome™ version 32 or later • Mozilla Firefox version 24 or later <p>Is your browser supported?</p>	Go to step 4.	Install a supported browser.
<p>Step 4 Check if the network connection is working.</p> <p>Is the network connection working?</p>	Go to step 5.	Contact your administrator.
<p>Step 5 Make sure that the cable connections to the printer and print server are secure. For more information, see the documentation that came with the printer.</p> <p>Are the cable connections secure?</p>	Go to step 6.	Secure the cable connections.
<p>Step 6 Check if the web proxy servers are disabled.</p> <p>Are the web proxy servers disabled?</p>	Go to step 7.	Contact your administrator.

Action	Yes	No
<p>Step 7 Access the Embedded Web Server.</p> <p>Did the Embedded Web Server open?</p>	The problem is solved.	Contact customer support .

Cannot connect the printer to the Wi-Fi network

Action	Yes	No
<p>Step 1 Make sure that Active Adapter is set to Auto. From the control panel, navigate to: Settings > OK > Network/Ports > OK > Network Overview > OK > Active Adapter > OK > Auto > OK</p> <p>Can the printer connect to the Wi-Fi network?</p>	The problem is solved.	Go to step 2.
<p>Step 2 Check if the correct Wi-Fi network is selected. Note: Some routers may share the default SSID.</p> <p>Are you connecting to the correct Wi-Fi network?</p>	Go to step 4.	Go to step 3.
<p>Step 3 Connect to the correct Wi-Fi network. For more information, see “Connecting the printer to a Wi-Fi network” on page 26.</p> <p>Can the printer connect to the Wi-Fi network?</p>	The problem is solved.	Go to step 4.
<p>Step 4 Check the wireless security mode. From the control panel, navigate to: Settings > OK > Network/Ports > OK > Wireless > OK > Wireless Security Mode > OK</p> <p>Is the correct wireless security mode selected?</p>	Go to step 6.	Go to step 5.
<p>Step 5 Select the correct wireless security mode.</p> <p>Can the printer connect to the Wi-Fi network?</p>	The problem is solved.	Go to step 6.
<p>Step 6 Make sure that you entered the correct network password. Note: Take note of the spaces, numbers, and capitalization in the password.</p> <p>Can the printer connect to the Wi-Fi network?</p>	The problem is solved.	Contact customer support .

Issues with supplies

Replace cartridge, printer region mismatch

To correct this problem, purchase a cartridge with the correct region that matches the printer region, or purchase a worldwide cartridge.

- The first number in the message after 42 indicates the region of the printer.
- The second number in the message after 42 indicates the region of the cartridge.

Printer and toner cartridge regions

Region	Numeric code
Worldwide or Undefined region	0
North America (United States, Canada)	1
European Economic Area, Western Europe, Nordic countries, Switzerland	2
Asia Pacific	3
Latin America	4
Rest of Europe, Middle East, Africa	5
Australia, New Zealand	6
Invalid region	9

Note: To find the region settings of the printer and toner cartridge, print the print quality test pages. From the control panel, navigate to: **Settings > Troubleshooting > Print Quality Test Pages.**

Non-Lexmark supply

The printer has detected a non-Lexmark supply or part installed in the printer.

Your Lexmark printer is designed to function best with genuine Lexmark supplies and parts. Use of third-party supplies or parts may affect the performance, reliability, or life of the printer and its imaging components.

All life indicators are designed to function with Lexmark supplies and parts and may deliver unpredictable results if third-party supplies or parts are used. Imaging component usage beyond the intended life may damage your Lexmark printer or associated components.

Warning—Potential Damage: Use of third-party supplies or parts can affect warranty coverage. Damage caused by the use of third-party supplies or parts may not be covered by the warranty.

To accept any and all of these risks and to proceed with the use of non-genuine supplies or parts in your printer, press and hold **X** and **OK** simultaneously for 15 seconds

If you do not want to accept these risks, then remove the third-party supply or part from your printer and install a genuine Lexmark supply or part. For more information, see [“Using genuine Lexmark parts and supplies” on page 70.](#)

If the printer does not print after pressing and holding **X** and **OK** simultaneously for 15 seconds, then reset the supply usage counter.

1 From the control panel, navigate to:

[Wrench icon] > **Device** > **OK** > **Maintenance** > **OK** > **Config Menu** > **OK** > **Supply Usage And Counters** > **OK**

2 Select the part or supply that you want to reset, and then select **OK**.

3 Read the warning message, and then select **Continue** > **OK**.

4 To clear the message, press and hold **X** and **OK** simultaneously for 15 seconds.

Note: If you are unable to reset the supply usage counters, then return the item to the place of purchase.

Clearing jams

Avoiding jams

Load paper properly

- Make sure that the paper lies flat in the tray.

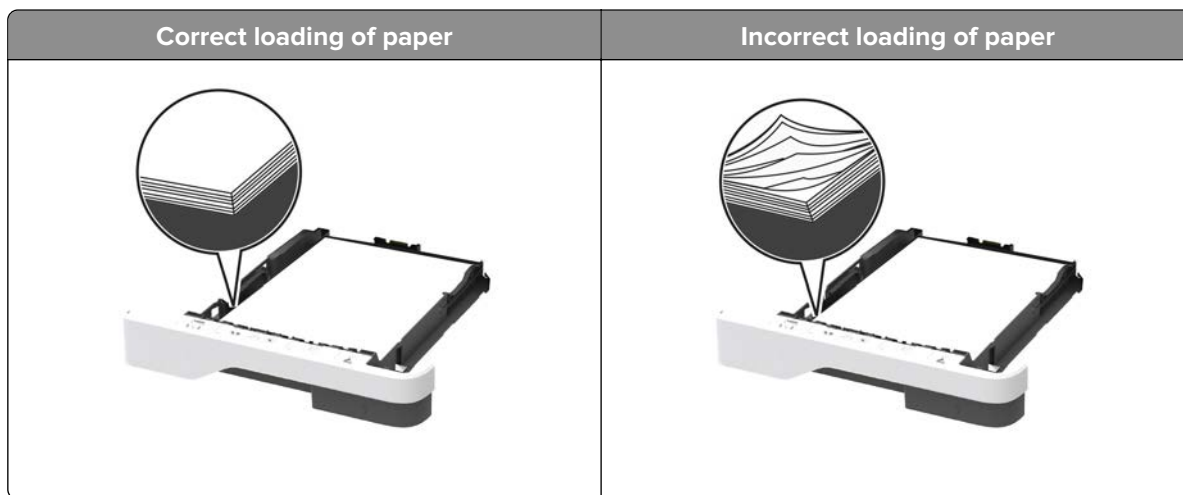

- Do not load or remove a tray while the printer is printing.
- Do not load too much paper. Make sure that the stack height is below the maximum paper fill indicator.

- Do not slide paper into the tray. Load paper as shown in the illustration.

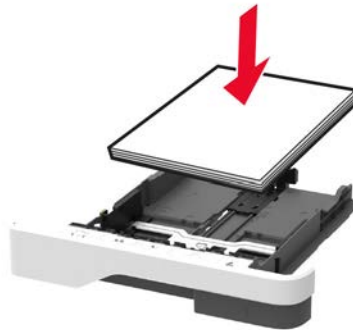

- Make sure that the paper guides are positioned correctly and are not pressing tightly against the paper or envelopes.
- Push the tray firmly into the printer after loading paper.

Use recommended paper

- Use only recommended paper or specialty media.
- Do not load paper that is wrinkled, creased, damp, bent, or curled.
- Flex, fan, and align the paper edges before loading.

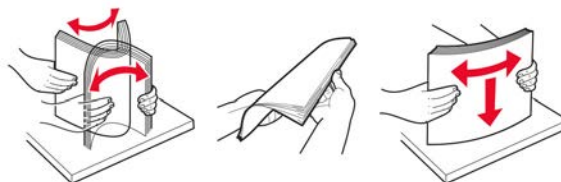

- Do not use paper that has been cut or trimmed by hand.
- Do not mix paper sizes, weights, or types in the same tray.
- Make sure that the paper size and type are set correctly on the computer or printer control panel.
- Store paper according to manufacturer recommendations.

Identifying jam locations

Notes:

- When Jam Assist is set to On, the printer flushes blank pages or pages with partial prints after a jammed page has been cleared. Check your printed output for blank pages.
- When Jam Recovery is set to On or Auto, the printer reprints jammed pages.

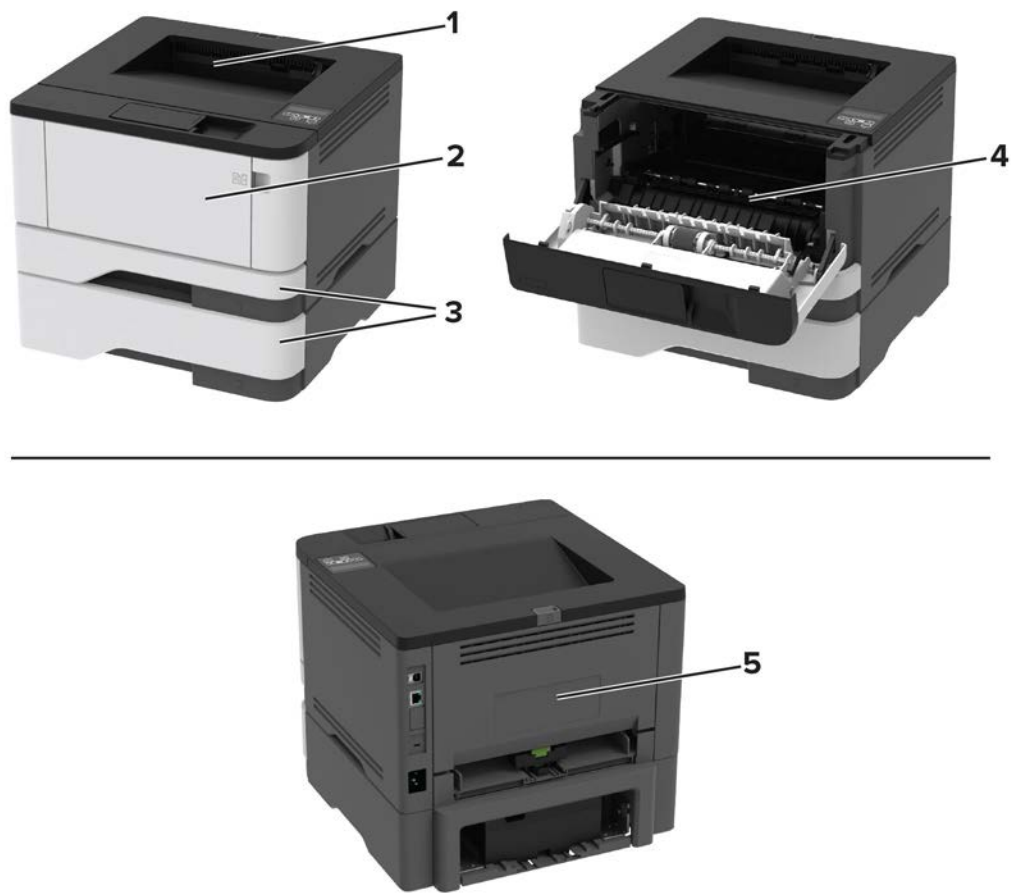

Jam locations	
1	Standard bin
2	Multipurpose feeder
3	Trays
4	Duplex unit
5	Rear door

Paper jam in the standard bin

Remove the jammed paper.

Note: Make sure that all paper fragments are removed.



Paper jam in the multipurpose feeder

- 1 Remove paper from the multipurpose feeder.



- 2 Remove the jammed paper.

Note: Make sure that all paper fragments are removed.

- 3 Close the multipurpose feeder.

- 4 Open the front door.

Warning—Potential Damage: To prevent damage from electrostatic discharge, touch any exposed metal frame of the printer before accessing or touching interior areas of the printer.

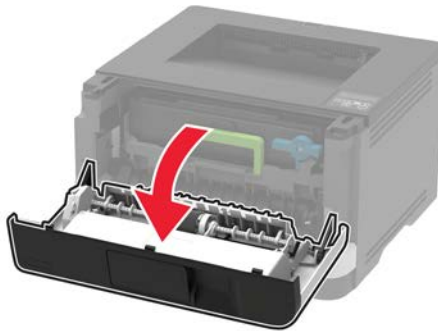

5 Remove the imaging unit.



Warning—Potential Damage: Do not expose the imaging unit to direct light for more than 10 minutes. Extended exposure to light may cause print quality problems.

Warning—Potential Damage: Do not touch the photoconductor drum. Doing so may affect the quality of future print jobs.



6 Remove the jammed paper.

 **CAUTION—HOT SURFACE:** The inside of the printer might be hot. To reduce the risk of injury from a hot component, allow the surface to cool before touching it.

Note: Make sure that all paper fragments are removed.



7 Insert the imaging unit.



8 Close the door.

9 Open the multipurpose feeder.

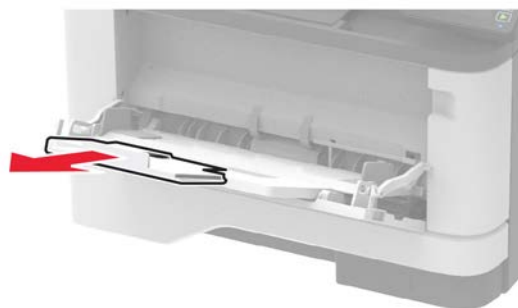

- 10** Flex, fan, and align the paper edges before loading.

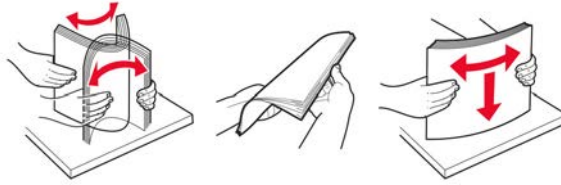

- 11** Reload paper.



Paper jam in trays

- 1** Remove the tray.



- 2** Open the front door.

Warning—Potential Damage: To prevent damage from electrostatic discharge, touch any exposed metal frame of the printer before accessing or touching interior areas of the printer.

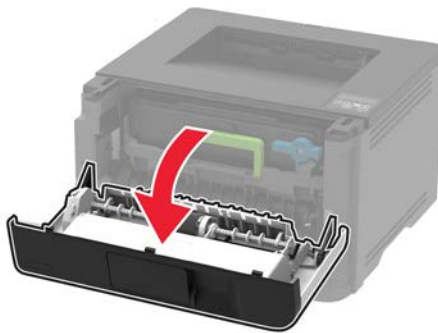
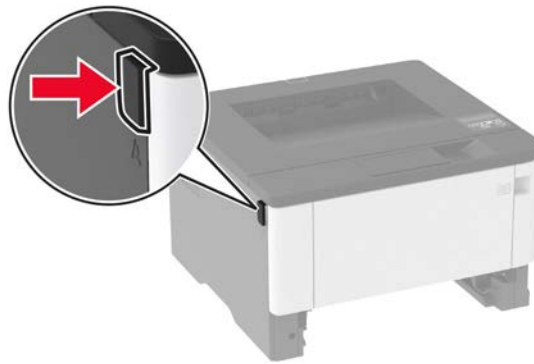

3 Remove the imaging unit.



Warning—Potential Damage: Do not expose the imaging unit to direct light for more than 10 minutes. Extended exposure to light may cause print quality problems.

Warning—Potential Damage: Do not touch the photoconductor drum. Doing so may affect the quality of future print jobs.



4 Remove the jammed paper.

 **CAUTION—HOT SURFACE:** The inside of the printer might be hot. To reduce the risk of injury from a hot component, allow the surface to cool before touching it.

Note: Make sure that all paper fragments are removed.



5 Insert the imaging unit.



6 Close the front door, and then insert the tray.

7 Open the rear door.

 **CAUTION—HOT SURFACE:** The inside of the printer might be hot. To reduce the risk of injury from a hot component, allow the surface to cool before touching it.



8 Remove the jammed paper.

Note: Make sure that all paper fragments are removed.



9 Close the rear door.

- 10 Remove the optional tray.



- 11 Remove the jammed paper.

Note: Make sure that all paper fragments are removed.



- 12 Insert the tray.

Paper jam in the duplex unit

- 1 Open the front door.

Warning—Potential Damage: To prevent damage from electrostatic discharge, touch any exposed metal frame of the printer before accessing or touching interior areas of the printer.

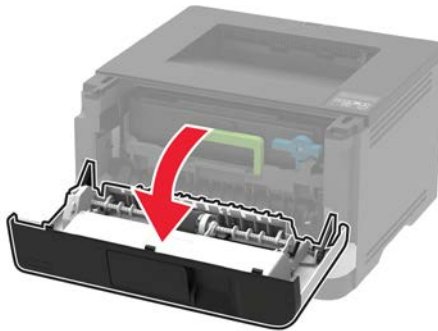

2 Remove the imaging unit.



Warning—Potential Damage: Do not expose the imaging unit to direct light for more than 10 minutes. Extended exposure to light may cause print quality problems.

Warning—Potential Damage: Do not touch the photoconductor drum. Doing so may affect the quality of future print jobs.



3 Remove the jammed paper.

 **CAUTION—HOT SURFACE:** The inside of the printer might be hot. To reduce the risk of injury from a hot component, allow the surface to cool before touching it.

Note: Make sure that all paper fragments are removed.



4 Insert the imaging unit.



5 Close the door.

6 Remove the tray.



7 Push the duplex unit latch to open the duplex unit.

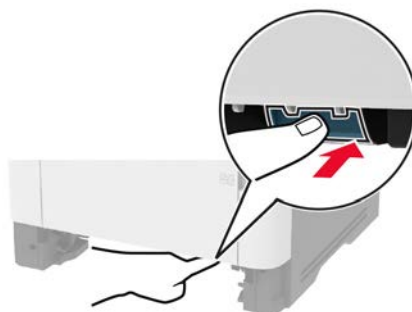

8 Remove the jammed paper.

Note: Make sure that all paper fragments are removed.



9 Close the duplex unit.

10 Insert the tray.

Paper jam in the rear door

1 Open the front door.

Warning—Potential Damage: To prevent damage from electrostatic discharge, touch any exposed metal frame of the printer before accessing or touching interior areas of the printer.

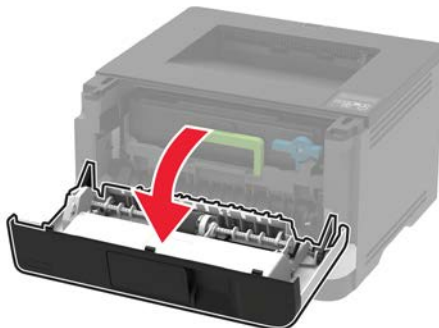

2 Remove the imaging unit.



Warning—Potential Damage: Do not expose the imaging unit to direct light for more than 10 minutes. Extended exposure to light may cause print quality problems.

Warning—Potential Damage: Do not touch the photoconductor drum. Doing so may affect the quality of future print jobs.



3 Open the rear door.

CAUTION—HOT SURFACE: The inside of the printer might be hot. To reduce the risk of injury from a hot component, allow the surface to cool before touching it.



4 Remove the jammed paper.

Note: Make sure that all paper fragments are removed.



5 Close the rear door.

6 Insert the imaging unit.



7 Close the front door.

Paper feed problems

Envelope seals when printing

Action	Yes	No
<p>Step 1</p> <p>a Use an envelope that has been stored in a dry environment. Note: Printing on envelopes with high moisture content can seal the flaps.</p> <p>b Send the print job.</p> <p>Does the envelope seal when printing?</p>	<p>Go to step 2.</p>	<p>The problem is solved.</p>
<p>Step 2</p> <p>a Make sure that paper type is set to Envelope. From the control panel, navigate to: Settings > OK > Paper > OK > Tray Configuration > OK > Paper Size/Type > OK</p> <p>b Send the print job.</p> <p>Does the envelope seal when printing?</p>	<p>Contact customer support.</p>	<p>The problem is solved.</p>

Collated printing does not work

Action	Yes	No
<p>Step 1</p> <p>a From the control panel, navigate to: Settings > OK > Print > OK > Layout > OK > Collate > OK</p> <p>b Set Collate to On [1,2,1,2,1,2], and then press OK.</p> <p>c Print the document.</p> <p>Is the document collated correctly?</p>	<p>The problem is solved.</p>	<p>Go to step 2.</p>
<p>Step 2</p> <p>a From the document that you are trying to print, open the Print dialog, and then select Collate.</p> <p>b Print the document.</p> <p>Is the document collated correctly?</p>	<p>The problem is solved.</p>	<p>Go to step 3.</p>
<p>Step 3</p> <p>a Reduce the number of pages to print.</p> <p>b Print the document.</p> <p>Are the pages collated correctly?</p>	<p>The problem is solved.</p>	<p>Contact customer support.</p>

Tray linking does not work

Action	Yes	No
<p>Step 1</p> <p>a Check if the trays contain the same paper size and paper type.</p> <p>b Check if the paper guides are positioned correctly.</p> <p>c Print the document.</p> <p>Do the trays link correctly?</p>	<p>The problem is solved.</p>	<p>Go to step 2.</p>
<p>Step 2</p> <p>a From the control panel, navigate to: Settings > OK > Paper > OK > Tray Configuration > OK > Paper Size/Type > OK</p> <p>b Set the paper size and paper type to match the paper loaded in the linked trays.</p> <p>c Print the document.</p> <p>Do the trays link correctly?</p>	<p>The problem is solved.</p>	<p>Go to step 3.</p>

Action	Yes	No
<p>Step 3</p> <p>a Make sure that Tray Linking is set to Automatic. For more information, see “Linking trays” on page 23.</p> <p>b Print the document.</p> <p>Do the trays link correctly?</p>	<p>The problem is solved.</p>	<p>Contact customer support.</p>

Paper frequently jams

Action	Yes	No
<p>Step 1</p> <p>a Remove the tray.</p> <p>b Check if paper is loaded correctly.</p> <p>Notes:</p> <ul style="list-style-type: none"> • Make sure that the paper guides are positioned correctly. • Make sure that the stack height is below the maximum paper fill indicator. • Make sure to print on recommended paper size and type. <p>c Insert the tray.</p> <p>d Print the document.</p> <p>Do paper jams occur frequently?</p>	<p>Go to step 2.</p>	<p>The problem is solved.</p>
<p>Step 2</p> <p>a From the control panel, navigate to:</p> <p>Settings > OK > Paper > OK > Tray Configuration > OK > Paper Size/Type > OK</p> <p>b Set the correct paper size and type.</p> <p>c Print the document.</p> <p>Do paper jams occur frequently?</p>	<p>Go to step 3.</p>	<p>The problem is solved.</p>
<p>Step 3</p> <p>a Load paper from a fresh package.</p> <p>Note: Paper absorbs moisture due to high humidity. Store paper in its original wrapper until you are ready to use it.</p> <p>b Print the document.</p> <p>Do paper jams occur frequently?</p>	<p>Contact customer support.</p>	<p>The problem is solved.</p>

Jammed pages are not reprinted

Action	Yes	No
<p>1 From the control panel, navigate to:</p> <p>Settings > OK > Device > OK > Notifications > OK > Jam Content Recovery > OK</p> <p>2 In the Jam Recovery menu, select On or Auto, and then press OK.</p> <p>Are the jammed pages reprinted?</p>	<p>The problem is solved.</p>	<p>Contact customer support.</p>

Contacting customer support

Before contacting customer support, make sure to have the following information:

- Printer problem
- Error message
- Printer model type and serial number

Go to <http://support.lexmark.com> to receive e-mail or chat support, or browse through the library of manuals, support documentation, drivers, and other downloads.

Technical support via telephone is also available. In the U.S. or Canada, call 1-800-539-6275. For other countries or regions, go to <http://support.lexmark.com>.

Recycle and dispose

Recycling Lexmark products

To return Lexmark products for recycling:

- 1 Go to www.lexmark.com/recycle.
- 2 Select the product you want to recycle.

Note: Printer supplies and hardware not listed in the Lexmark Collection and Recycling Program may be recycled through your local recycling center.

Recycling Lexmark packaging

Lexmark continually strives to minimize packaging. Less packaging helps to ensure that Lexmark printers are transported in the most efficient and environmentally sensitive manner and that there is less packaging to dispose of. These efficiencies result in fewer greenhouse emissions, energy savings, and natural resource savings. Lexmark also offers recycling of packaging components in some countries or regions. For more information, go to www.lexmark.com/recycle, and then choose your country or region. Information on available packaging recycling programs is included with the information on product recycling.

Lexmark cartons are 100% recyclable where corrugated recycling facilities exist. Facilities may not exist in your area.

The foam used in Lexmark packaging is recyclable where foam recycling facilities exist. Facilities may not exist in your area.

When you return a cartridge to Lexmark, you can reuse the box that the cartridge came in. Lexmark recycles the box.

Notices

Product information

Product name:

Lexmark B3340dw; Lexmark B3442dw; Lexmark M1342, Lexmark MS331dn; Lexmark MS431dn, Lexmark MS431dw; Lexmark MS439dn printers

Machine type:

4601

Models:

230, 280, 4a0, 480, 489

Edition notice

March 2021

The following paragraph does not apply to any country where such provisions are inconsistent with local law: LEXMARK INTERNATIONAL, INC., PROVIDES THIS PUBLICATION "AS IS" WITHOUT WARRANTY OF ANY KIND, EITHER EXPRESS OR IMPLIED, INCLUDING, BUT NOT LIMITED TO, THE IMPLIED WARRANTIES OF MERCHANTABILITY OR FITNESS FOR A PARTICULAR PURPOSE. Some states do not allow disclaimer of express or implied warranties in certain transactions; therefore, this statement may not apply to you.

This publication could include technical inaccuracies or typographical errors. Changes are periodically made to the information herein; these changes will be incorporated in later editions. Improvements or changes in the products or the programs described may be made at any time.

References in this publication to products, programs, or services do not imply that the manufacturer intends to make these available in all countries in which it operates. Any reference to a product, program, or service is not intended to state or imply that only that product, program, or service may be used. Any functionally equivalent product, program, or service that does not infringe any existing intellectual property right may be used instead. Evaluation and verification of operation in conjunction with other products, programs, or services, except those expressly designated by the manufacturer, are the user's responsibility.

For Lexmark technical support, go to <http://support.lexmark.com>.

For information on Lexmark's privacy policy governing the use of this product, go to www.lexmark.com/privacy.

For information on supplies and downloads, go to www.lexmark.com.

© 2020 Lexmark International, Inc.

All rights reserved.

GOVERNMENT END USERS

The Software Program and any related documentation are "Commercial Items," as that term is defined in 48 C.F.R. 2.101, "Computer Software" and "Commercial Computer Software Documentation," as such terms are used in 48 C.F.R. 12.212 or 48 C.F.R. 227.7202, as applicable. Consistent with 48 C.F.R. 12.212 or 48 C.F.R. 227.7202-1 through 227.7207-4, as applicable, the Commercial Computer Software and Commercial Software

Documentation are licensed to the U.S. Government end users (a) only as Commercial Items and (b) with only those rights as are granted to all other end users pursuant to the terms and conditions herein.

Trademarks

Lexmark and the Lexmark logo are trademarks or registered trademarks of Lexmark International, Inc. in the United States and/or other countries.

Android, Google Play, and Google Chrome are trademarks of Google LLC.

Macintosh, macOS, Safari, and AirPrint are trademarks of Apple Inc., registered in the U.S. and other countries. App Store is a service mark of Apple Inc., registered in the U.S. and other countries. Use of the Works with Apple badge means that an accessory has been designed to work specifically with the technology identified in the badge and has been certified by the developer to meet Apple performance standards.

The Mopria® word mark is a registered and/or unregistered trademark of Mopria Alliance, Inc. in the United States and other countries. Unauthorized use is strictly prohibited.

PCL® is a registered trademark of the Hewlett-Packard Company. PCL is Hewlett-Packard Company’s designation of a set of printer commands (language) and functions included in its printer products. This printer is intended to be compatible with the PCL language. This means the printer recognizes PCL commands used in various application programs, and that the printer emulates the functions corresponding to the commands.

PostScript is a registered trademark of Adobe Systems Incorporated in the United States and/or other countries.

Wi-Fi® and Wi-Fi Direct® are registered trademarks of Wi-Fi Alliance®.

All other trademarks are the property of their respective owners.

Licensing notices

All licensing notices associated with this product can be viewed from the CD:\NOTICES directory of the installation software CD.

Noise emission levels

The following measurements were made in accordance with ISO 7779 and reported in conformance with ISO 9296.

Note: Some modes may not apply to your product.

1-meter average sound pressure, dBA	
Printing	One-sided: 53 Two-sided: 50
Ready	14

Values are subject to change. See www.lexmark.com for current values.

Waste from Electrical and Electronic Equipment (WEEE) directive



The WEEE logo signifies specific recycling programs and procedures for electronic products in countries of the European Union. We encourage the recycling of our products.

If you have further questions about recycling options, visit the Lexmark Web site at www.lexmark.com for your local sales office phone number.

India E-Waste notice



This product including components, consumables, parts and spares complies with the “India E-Waste Rules” and prohibits use of lead, mercury, hexavalent chromium, polybrominated biphenyls or polybrominated diphenyl ethers in concentrations exceeding 0.1% by weight and 0.01% by weight for cadmium, except for the exemption set in the Rule.

Product disposal

Do not dispose of the printer or supplies in the same manner as normal household waste. Consult your local authorities for disposal and recycling options.

EU battery directive

This product may contain a coin-cell lithium rechargeable battery. This product is in compliance with EU Directive 2006/66/EC as amended by Directive 2008/12/EC, 2008/103/EC, and 2013/56/EU.

Returning Lexmark cartridges for reuse or recycling

The Lexmark Cartridge Collection Program allows you to return used cartridges for free to Lexmark for reuse or recycling. One hundred percent of the empty cartridges returned to Lexmark are either reused or demanufactured for recycling. The boxes used to return the cartridges are also recycled.

To return Lexmark cartridges for reuse or recycling, do the following:

- 1 Go to www.lexmark.com/recycle.
- 2 Select the product that you want to recycle.

Static sensitivity notice



This symbol identifies static-sensitive parts. Do not touch the areas near these symbols without first touching a metal surface in an area away from the symbol.

To prevent damage from electrostatic discharge when performing maintenance tasks such as clearing paper jams or replacing supplies, touch any exposed metal frame of the printer before accessing or touching interior areas of the printer even if the symbol is not present.

ENERGY STAR

Any Lexmark product bearing the ENERGY STAR® emblem on the product or on a start-up screen is certified to comply with Environmental Protection Agency (EPA) ENERGY STAR requirements as of the date of manufacture.



Temperature information

Ambient operating temperature	10 to 32.2°C (50 to 90°F)
Shipping temperature	-40 to 40°C (-40 to 104°F)
Storage temperature and relative humidity	-40 to 40°C (-40 to 104°F) 8 to 80% RH

Laser notice

The printer is certified in the U.S. to conform to the requirements of DHHS 21 CFR, Chapter I, Subchapter J for Class I (1) laser products, and elsewhere is certified as a Class I laser product conforming to the requirements of IEC 60825-1: 2014.

Class I laser products are not considered to be hazardous. The laser system and printer are designed so there is never any human access to laser radiation above a Class I level during normal operation, user maintenance,

or prescribed service conditions. The printer has a non-serviceable printhead assembly that contains a laser with the following specifications:

Class: IIIb (3b) AlGaInP

Nominal output power (milliwatts): 25

Wavelength (nanometers): 775–800

Power consumption

Product power consumption

The following table documents the power consumption characteristics of the product.

Note: Some modes may not apply to your product.

Mode	Description	Power consumption (Watts)
Printing	The product is generating hard-copy output from electronic inputs.	One-sided: 550 (B3340, MS331); 570 (B3442, M1342, MS431, MS439) Two-sided: 300 (B3340, MS331); 305 (B3442, M1342, MS431, MS439)
Copy	The product is generating hard-copy output from hard-copy original documents.	N/A
Scan	The product is scanning hard-copy documents.	N/A
Ready	The product is waiting for a print job.	5.5 (B3340, MS331), 4.9 (B3442, M1342, MS431, MS439)
Sleep Mode	The product is in a high-level energy-saving mode.	0.9
Hibernate	The product is in a low-level energy-saving mode.	0.1
Off	The product is plugged into an electrical outlet, but the power switch is turned off.	0.1

The power consumption levels listed in the previous table represent time-averaged measurements. Instantaneous power draws may be substantially higher than the average.

Values are subject to change. See www.lexmark.com for current values.

Sleep Mode

This product is designed with an energy-saving mode called *Sleep Mode*. The Sleep Mode saves energy by lowering power consumption during extended periods of inactivity. The Sleep Mode is automatically engaged after this product is not used for a specified period of time, called the *Sleep Mode Timeout*.

Factory default Sleep Mode Timeout for this product (in minutes):	15
---	----

By using the configuration menus, the Sleep Mode Timeout can be modified between 1 minute and 120 minutes. If the print speed is less than or equal to 30 pages per minute, then you can set the timeout only up to 60 minutes. Setting the Sleep Mode Timeout to a low value reduces energy consumption, but may increase the

response time of the product. Setting the Sleep Mode Timeout to a high value maintains a fast response, but uses more energy.

Hibernate Mode

This product is designed with an ultra-low power operating mode called *Hibernate mode*. When operating in Hibernate Mode, all other systems and devices are powered down safely.

The Hibernate mode can be entered in any of the following methods:

- Using the Hibernate Timeout
- Using the Schedule Power modes

Factory default Hibernate Timeout for this product in all countries or regions	3 days
--	--------

The amount of time the printer waits after a job is printed before it enters Hibernate mode can be modified between one hour and one month.

Off mode

If this product has an off mode which still consumes a small amount of power, then to completely stop product power consumption, disconnect the power supply cord from the electrical outlet.

Total energy usage

It is sometimes helpful to estimate the total product energy usage. Since power consumption claims are provided in power units of Watts, the power consumption should be multiplied by the time the product spends in each mode in order to calculate energy usage. The total product energy usage is the sum of each mode's energy usage.

Regulatory notices for wireless products

This section contains regulatory information that applies only to wireless models.

If in doubt as to whether your model is a wireless model, go to <http://support.lexmark.com>.

Modular component notice

Wireless models contain the following modular component:

Regulatory Type/Model Number LEX-M08-001; FCC ID:IYLLEXM08001; IC:2376A-LEXM08001

To determine which modular components are installed in your particular product, refer to the labeling on your actual product.

Exposure to radio frequency radiation

The radiated output power of this device is far below the radio frequency exposure limits of the FCC and other regulatory agencies. A minimum separation of 20 cm (8 inches) must be maintained between the antenna and any persons for this device to satisfy the RF exposure requirements of the FCC and other regulatory agencies.

Innovation, Science and Economic Development Canada

This device complies with Innovation, Science and Economic Development Canada license-exempt RSS standards. Operation is subject to the following two conditions: (1) this device may not cause interference, and (2) this device must accept any interference, including interference that may cause undesired operation of the device.

Innovation, Sciences et Développement économique Canada

Cet appareil est conforme aux normes RSS exemptes de licence d'Innovation, Sciences et Développement économique Canada. Son fonctionnement est soumis aux deux conditions suivantes : (1) cet appareil ne doit pas causer d'interférences et (2) il doit accepter toutes les interférences, y compris les celles qui peuvent entraîner un fonctionnement indésirable.

Federal Communications Commission (FCC) compliance information statement

This product has been tested and found to comply with the limits for a Class B digital device, pursuant to Part 15 of the FCC Rules. Operation is subject to the following two conditions: (1) this device may not cause harmful interference, and (2) this device must accept any interference received, including interference that may cause undesired operation.

The FCC Class B limits are designed to provide reasonable protection against harmful interference when the equipment is operated in a residential installation. This equipment generates, uses, and can radiate radio frequency energy and, if not installed and used in accordance with the instructions, may cause harmful interference to radio communications. However, there is no guarantee that interference will not occur in a particular installation. If this equipment does cause harmful interference to radio or television reception, which can be determined by turning the equipment off and on, the user is encouraged to try to correct the interference by one or more of the following measures:

- Reorient or relocate the receiving antenna.
- Increase the separation between the equipment and receiver.
- Connect the equipment into an outlet on a circuit different from that to which the receiver is connected.
- Consult your point of purchase or service representative for additional suggestions.

The manufacturer is not responsible for radio or television interference caused by using other than recommended cables or by unauthorized changes or modifications to this equipment. Unauthorized changes or modifications could void the user's authority to operate this equipment.

Note: To assure compliance with FCC regulations on electromagnetic interference for a Class B computing device, use a properly shielded and grounded cable such as Lexmark part number 1021231 for parallel attach or 1021294 for USB attach. Use of a substitute cable not properly shielded and grounded may result in a violation of FCC regulations.

Any questions regarding this compliance information statement should be directed to:

Director of Lexmark Technology & Services
Lexmark International, Inc.
740 West New Circle Road
Lexington, KY 40550
Telephone: (859) 232-2000
E-mail: regulatory@lexmark.com

Innovation, Science and Economic Development Canada compliance statement

This Class B digital apparatus meets all requirements of the Canadian Interference-Causing Equipment Standard ICES-003.

Avis de conformité aux normes de l'Innovation, Sciences et Développement économique Canada

Cet appareil numérique de classe B est conforme aux exigences de la norme canadienne relative aux équipements pouvant causer des interférences NMB-003.

日本の VCCI 規定

製品にこのマークが表示されている場合、次の要件を満たしています。



この装置は、クラス B 情報技術装置です。この装置は、家庭環境で使用することを目的としていますが、この装置がラジオやテレビジョン受信機に近接して使用されると、受信障害を引き起こすことがあります。

取扱説明書に従って正しい取り扱いをしてください。

VCCI-B

European Community (EC) directives conformity

This product is in conformity with the protection requirements of EC Council directive 2014/53/EU on the approximation and harmonization of the laws of the Member States relating to radio equipment.

The manufacturer of this product is: Lexmark International, Inc., 740 West New Circle Road, Lexington, KY, 40550 USA. The EEA/EU authorized representative is: Lexmark International Technology Hungária Kft., 8 Lechner Ödön fasor, Millennium Tower III, 1095 Budapest HUNGARY. The EEA/EU Importer is: Lexmark International Technology S.à.r.l. 20, Route de Pré-Bois, ICC Building, Bloc A, CH-1215 Genève, Switzerland. A declaration of conformity to the requirements of the Directives is available upon request from the Authorized Representative or may be obtained at

www.lexmark.com/en_us/about/regulatory-compliance/european-union-declaration-of-conformity.html.

Compliance is indicated by the CE marking:



EU and other countries statement of radio transmitter operational frequency bands and maximum RF power

This radio product transmits in the 2.4GHz (2.412–2.472GHz) band in the EU. The maximum transmitter EIRP power output, including antenna gain, is $\leq 20\text{dBm}$.

United Kingdom (UK) conformity

This product is in conformity with the protection requirements of the Radio Equipment Regulations 2017.

The manufacturer of this product is: Lexmark International, Inc., 740 West New Circle Road, Lexington, KY, 40550 USA. The UK Importer is: Lexmark International Ltd, Highfield House, Foundation Park - 8 Roxborough Way, Maidenhead Berkshire - SL6 3UD, United Kingdom. A declaration of conformity is available upon request from the UK Importer or may be obtained at

www.lexmark.com/en_us/about/regulatory-compliance/uk-declaration-of-conformity.html.

Compliance is indicated by the UKCA marking:



UK statement of radio transmitter operational frequency bands and maximum RF power

This radio product transmits in the 2.4GHz (2.412–2.472GHz) band in the UK. The maximum transmitter EIRP power output, including antenna gain, is $\leq 20\text{dBm}$.

European Community (EC) directives conformity

This product is in conformity with the protection requirements of EC Council directives 2014/30/EU, 2014/35/EU, 2009/125/EC, and 2011/65/EU as amended by (EU) 2015/863 on the approximation and harmonization of the laws of the Member States relating to electromagnetic compatibility, safety of electrical equipment designed for use within certain voltage limits, the ecodesign of energy-related products, and on the restrictions of use of certain hazardous substances in electrical and electronic equipment.

The manufacturer of this product is: Lexmark International, Inc., 740 West New Circle Road, Lexington, KY, 40550 USA. The EEA/EU authorized representative is: Lexmark International Technology Hungária Kft., 8 Lechner Ödön fasor, Millennium Tower III, 1095 Budapest HUNGARY. The EEA/EU Importer is: Lexmark International Technology S.à.r.l. 20, Route de Pré-Bois, ICC Building, Bloc A, CH-1215 Genève, Switzerland. A declaration of conformity to the requirements of the Directives is available upon request from the Authorized Representative or may be obtained at

www.lexmark.com/en_us/about/regulatory-compliance/european-union-declaration-of-conformity.html.

This product satisfies the Class B limits of EN 55032 and safety requirements of EN 62368-1.

United Kingdom (UK) conformity

This product is in conformity with the protection requirements of the Electromagnetic Compatibility Regulations 2016, the Electrical Equipment (Safety) Regulations 2016, the Ecodesign for Energy-Related Products and

Energy Information (Amendment) (EU Exit) Regulations 2019, and the Restriction of the Use of Certain Hazardous Substances in Electrical and Electronic Equipment Regulations 2012.

The manufacturer of this product is: Lexmark International, Inc., 740 West New Circle Road, Lexington, KY, 40550 USA. The UK Importer is: Lexmark International Ltd, Highfield House, Foundation Park - 8 Roxborough Way, Maidenhead Berkshire - SL6 3UD, United Kingdom. A declaration of conformity is available upon request from the UK Importer or may be obtained at

www.lexmark.com/en_us/about/regulatory-compliance/uk-declaration-of-conformity.html.

This product satisfies the Class B limits of BS EN 55032 and safety requirements of BS EN 62368-1.

STATEMENT OF LIMITED WARRANTY FOR LEXMARK LASER PRINTERS, LEXMARK LED PRINTERS, AND LEXMARK MULTIFUNCTION LASER PRINTERS

Lexmark International, Inc., Lexington, KY

This limited warranty applies to the United States and Canada. For customers outside the U.S., refer to the country-specific warranty information that came with your product.

This limited warranty applies to this product only if it was originally purchased for your use, and not for resale, from Lexmark or a Lexmark Remarketer, referred to in this statement as “Remarketer.”

Limited warranty

Lexmark warrants that this product:

- Is manufactured from new parts, or new and serviceable used parts, which perform like new parts
- Is, during normal use, free from defects in material and workmanship

If this product does not function as warranted during the warranty period, contact a Remarketer or Lexmark for repair or replacement (at Lexmark's option).

If this product is a feature or option, this statement applies only when that feature or option is used with the product for which it was intended. To obtain warranty service, you may be required to present the feature or option with the product.

If you transfer this product to another user, warranty service under the terms of this statement is available to that user for the remainder of the warranty period. You should transfer proof of original purchase and this statement to that user.

Limited warranty service

The warranty period starts on the date of original purchase as shown on the purchase receipt and ends 12 months later provided that the warranty period for any supplies and for any maintenance items included with the printer shall end earlier if it, or its original contents, are substantially used up, depleted, or consumed. Fuser Units, Transfer/Transport Units, Paper Feed items, if any, and any other items for which a Maintenance Kit is available are substantially consumed when the printer displays a “Life Warning” or “Scheduled Maintenance” message for such item.

To obtain warranty service you may be required to present proof of original purchase. You may be required to deliver your product to the Remarketer or Lexmark, or ship it prepaid and suitably packaged to a Lexmark

designated location. You are responsible for loss of, or damage to, a product in transit to the Remarketer or the Lexmark designated location.

When warranty service involves the exchange of a product or part, the item replaced becomes the property of the Remarketer or Lexmark. The replacement may be a new or repaired item.

The replacement item assumes the remaining warranty period of the original product.

Replacement is not available to you if the product you present for exchange is defaced, altered, in need of a repair not included in warranty service, damaged beyond repair, or if the product is not free of all legal obligations, restrictions, liens, and encumbrances.

As part of your warranty service and/or replacement, Lexmark may update the firmware in your printer to the latest version. Firmware updates may modify printer settings and cause counterfeit and/or unauthorized products, supplies, parts, materials (such as toners and inks), software, or interfaces to stop working. Authorized use of genuine Lexmark products will not be impacted.

Before you present this product for warranty service, remove all print cartridges, programs, data, and removable storage media (unless directed otherwise by Lexmark).

For further explanation of your warranty alternatives and the nearest Lexmark authorized servicer in your area contact Lexmark on the World Wide Web.

Remote technical support is provided for this product throughout its warranty period. For products no longer covered by a Lexmark warranty, technical support may not be available or only be available for a fee.

Extent of limited warranty

Lexmark does not warrant uninterrupted or error-free operation of any product or the durability or longevity of prints produced by any product.

Warranty service does not include repair of failures caused by:

- Modification or unauthorized attachments
- Accidents, misuse, abuse or use inconsistent with Lexmark user's guides, manuals, instructions or guidance
- Unsuitable physical or operating environment
- Maintenance by anyone other than Lexmark or a Lexmark authorized servicer
- Operation of a product beyond the limit of its duty cycle
- Use of printing media outside of Lexmark specifications
- Refurbishment, repair, refilling or remanufacture by a third party of products, supplies or parts
- Products, supplies, parts, materials (such as toners and inks), software, or interfaces not furnished by Lexmark

TO THE EXTENT PERMITTED BY APPLICABLE LAW, NEITHER LEXMARK NOR ITS THIRD PARTY SUPPLIERS OR REMARKETERS MAKE ANY OTHER WARRANTY OR CONDITION OF ANY KIND, WHETHER EXPRESS OR IMPLIED, WITH RESPECT TO THIS PRODUCT, AND SPECIFICALLY DISCLAIM THE IMPLIED WARRANTIES OR CONDITIONS OF MERCHANTABILITY, FITNESS FOR A PARTICULAR PURPOSE, AND SATISFACTORY QUALITY. ANY WARRANTIES THAT MAY NOT BE DISCLAIMED UNDER APPLICABLE LAW ARE LIMITED IN DURATION TO THE WARRANTY PERIOD. NO WARRANTIES, EXPRESS OR IMPLIED, WILL APPLY AFTER THIS PERIOD. ALL INFORMATION, SPECIFICATIONS, PRICES, AND SERVICES ARE SUBJECT TO CHANGE AT ANY TIME WITHOUT NOTICE.

Limitation of liability

Your sole remedy under this limited warranty is set forth in this document. For any claim concerning performance or nonperformance of Lexmark or a Remarketer for this product under this limited warranty, you may recover actual damages up to the limit set forth in the following paragraph.

Lexmark's liability for actual damages from any cause whatsoever will be limited to the amount you paid for the product that caused the damages. This limitation of liability will not apply to claims by you for bodily injury or damage to real property or tangible personal property for which Lexmark is legally liable. **IN NO EVENT WILL LEXMARK BE LIABLE FOR ANY LOST PROFITS, LOST SAVINGS, INCIDENTAL DAMAGE, OR OTHER ECONOMIC OR CONSEQUENTIAL DAMAGES.** This is true even if you advise Lexmark or a Remarketer of the possibility of such damages. Lexmark is not liable for any claim by you based on a third party claim.

This limitation of remedies also applies to claims against any Suppliers and Remarketers of Lexmark. Lexmark's and its Suppliers' and Remarketers' limitations of remedies are not cumulative. Such Suppliers and Remarketers are intended beneficiaries of this limitation.

Additional rights

Some states do not allow limitations on how long an implied warranty lasts, or do not allow the exclusion or limitation of incidental or consequential damages, so the limitations or exclusions contained above may not apply to you.

This limited warranty gives you specific legal rights. You may also have other rights that vary from state to state.

Index

A

- adding hardware options
 - print driver 26
- adding internal options
 - print driver 26
- adding printers to a computer 24
- adjusting toner darkness 37
- AirPrint
 - using 34
- attaching cables 19
- avoiding paper jams 121

B

- blank pages 90

C

- canceling a print job
 - from the computer 36
 - from the printer control panel 36
- cannot connect printer to Wi-Fi 119
- cannot open Embedded Web Server 118
- checking the status
 - parts and supplies 69
- cleaning
 - exterior of the printer 83
 - interior of the printer 83
- cleaning pick roller assembly 83
- cleaning the printer 83
- clearing jam
 - in the duplex unit 130
 - in the multipurpose feeder 124
 - in the rear door 133
 - in trays 127
- collated printing does not work 136
- computer
 - connecting to the printer 29
- confidential print jobs
 - configuring 34
- confidential print jobs do not print 115
- configuring supply notifications 69

- configuring the settings
 - Universal paper 20
- configuring Wi-Fi Direct 28
- connecting a computer to the printer 29
- connecting mobile device to printer 28
- connecting the printer to a wireless network 26
- connecting to a wireless network
 - using PIN method 27
 - using Push Button method 27
- conserving supplies 87
- contacting customer support 138
- control panel
 - using 11
- crooked print 102
- customer support
 - contacting 138
- cut off images 104
- cut off text 104

D

- dark print 91
- deactivating Wi-Fi network 29
- documents, printing
 - from a computer 33
 - from a mobile device 33
- dots on print 99

E

- emission notices 141, 145, 147
- enabling Wi-Fi Direct 28
- envelope seals when printing 135
- environmental settings 87
- erasing printer memory 31
- Ethernet port 19
- exporting a configuration file using the Embedded Web Server 25
- e-mail alerts
 - setting up 69

F

- factory default settings
 - restoring 31

- FCC notices 145
- finding printer information 8
- finding the printer serial number 9
- fine lines are not printed correctly 93
- firmware, updating 25
- folder paper 94
- font sample list
 - printing 36

G

- genuine Lexmark parts and supplies 70
- genuine parts and supplies 70
- gray background on prints 95

H

- hardware options
 - trays 19
- hardware options, adding
 - print driver 26
- held jobs do not print 115
- Hibernate mode
 - setting 87
- horizontal light bands 105

I

- identifying jam locations 122
- images cut off 104
- imaging unit
 - ordering 72
 - replacing 75
- importing a configuration file using the Embedded Web Server 25
- incorrect margins 97
- indicator light
 - understanding the status 11
- installing the print driver 23
- installing the printer software 23
- installing trays 19
- internal options, adding
 - print driver 26

J

jammed pages are not reprinted 138
jams
 avoiding 121
jams, clearing
 in the standard bin 123

L

letterhead
 selecting 13
Lexmark Mobile Print
 using 33
light print 97
linking trays 23
loading envelopes
 in the multipurpose feeder 22
loading letterhead
 in the multipurpose feeder 22
loading trays 20
locating jam areas 122
locating the security slot 31

M

memory
 types installed on printer 32
menu
 802.1x 61
 About this Printer 45
 Anonymous Data Collection 42
 Certificate Management 65
 Confidential Print Setup 66
 Config Menu 43
 Device 67
 Eco-Mode 39
 Erase Temporary Data Files 67
 Ethernet 56
 HTTP/FTP Settings 62
 Image 50
 IPSec 59
 Layout 45
 Local Accounts 64
 Login Restrictions 65
 LPD Configuration 61
 Media Types 52
 Menu Settings Page 67
 Miscellaneous 67
 Network 68
 Network Overview 52
 Notifications 40
 Out of Service Erase 45

PCL 48
PostScript 48
Power Management 41
Preferences 38
Print 68
Public 64
Quality 47
Restore Factory Defaults 42
Restrict external network
 access 63
 Setup 47
SNMP 58
TCP/IP 57
Tray Configuration 50
Troubleshooting 68
Universal Setup 51
USB 62
Wireless 53
Wi-Fi Direct 55
Menu Settings Page
 printing 30
missing print 110
mobile device
 connecting to printer 28
 printing from 33, 34
Mopria Print Service 33
mottled print 99
moving the printer 18, 87
multipurpose feeder
 loading 22

N

noise emission levels 141
Non-Lexmark supply 120
non-volatile memory 32
 erasing 31
notices 141, 142, 143, 144, 145, 147

O

ordering supplies
 imaging unit 72
 toner cartridge 70

P

paper
 letterhead 13
 preprinted forms 13
 selecting 12
 unacceptable 13
paper characteristics 12
paper curl 100
paper guidelines 12
paper jam
 in the rear door 133
 in trays 127
paper jam in the duplex unit 130
paper jam in the multipurpose feeder 124
paper jams
 avoiding 121
 location 122
paper jams, clearing
 in the standard bin 123
paper sizes, supported 14
paper types, supported 16
paper weights, supported 17
parts and supplies
 status, checking 69
personal identification number method 27
pick roller assembly
 cleaning 83
 replacing 78
placing separator sheets 36
power cord socket 19
power saver modes
 setting 87
preprinted forms
 selecting 13
print driver
 hardware options, adding 26
 installing 23
print job
 canceling from the computer 36
 canceling from the printer control panel 36
print jobs not printed 112
print quality problems 89
Print Quality Test Pages 68
print quality troubleshooting
 blank or white pages 90
 crooked print 102
 dark print 91
 fine lines are not printed correctly 93
 folded or wrinkled paper 94
 gray background on prints 95
 horizontal light bands 105
 light print 97
 mottled print and dots 99
 paper curl 100
 repeating defects 111

- skewed print 102
- solid black pages 103
- text or images cut off 104
- toner easily rubs off 105
- vertical dark bands 108
- vertical dark lines or streaks 109
- vertical dark streaks with print missing 110
- vertical light bands 106
- vertical white lines 107
- print troubleshooting
 - collated printing does not work 136
 - confidential and other held documents do not print 115
 - envelope seals when printing 135
 - incorrect margins 97
 - jammed pages are not reprinted 138
 - job prints from the wrong tray 114
 - job prints on the wrong paper 114
 - paper frequently jams 137
 - print jobs do not print 112
 - print quality problems 89
 - slow printing 113
 - tray linking does not work 136
- printer
 - minimum clearances 18
 - selecting a location 18
 - shipping 88
- printer configuration 10
- printer connectivity
 - checking 29
- printer information
 - finding 8
- printer is not responding 116
- printer memory
 - erasing 31
- printer menus 38
- printer messages
 - Non-Lexmark supply 120
 - Replace cartridge, printer region mismatch 120
- printer ports 19
- printer settings
 - restoring to factory defaults 31
- printer software
 - installing 23

- printer status 11
- printing
 - confidential print jobs 35
 - font sample list 36
 - from a computer 33
 - from a mobile device 33, 34
 - held jobs 35
 - Menu Settings Page 30
 - Network Setup Page 29
 - repeat print jobs 35
 - reserve print jobs 35
 - using Mopria Print Service 33
 - using Wi-Fi Direct 34
 - verify print jobs 35
- printing from a computer 33
- Push Button method 27

R

- recycling
 - Lexmark packaging 139
 - Lexmark products 139
- removing paper jam
 - in the duplex unit 130
 - in the multipurpose feeder 124
 - in the rear door 133
 - in trays 127
- repeating defects on print 111
- Replace cartridge, printer region mismatch 120
- replacing parts
 - pick roller assembly 78
 - tray 78
 - tray separator roller 82
- replacing supplies
 - imaging unit 75
 - toner cartridge 73
- reports
 - viewing 70
- resetting
 - supply usage counters 120
- resetting counters 83

S

- safety information 5, 6, 7
- security slot
 - locating 31
- selecting a location for the printer 18
- separator sheets
 - placing 36

- serial number, printer
 - finding 9
- setting the paper size 20
- setting the paper type 20
- setting up e-mail alerts 69
- shipping the printer 88
- skewed print 102
- Sleep mode
 - setting 87
- slow printing 113
- solid black pages 103
- statement of volatility 32
- storing paper 13
- supplies
 - conserving 87
 - supply notifications
 - configuring 69
 - supply usage counters
 - resetting 83, 120
- supported paper sizes 14
- supported paper types 16
- supported paper weights 17

T

- text cut off 104
- toner cartridge
 - ordering 70
 - replacing 73
- toner darkness
 - adjusting 37
- toner easily rubs off 105
- tray linking does not work 136
- tray separator roller
 - replacing 82
- trays
 - installing 19
 - linking 23
 - loading 20
 - replacing 78
 - unlinking 23
- troubleshooting
 - cannot connect printer to Wi-Fi 119
 - cannot open Embedded Web Server 118
 - print quality problems 89
 - printer is not responding 116
 - troubleshooting, print
 - collated printing does not work 136
 - confidential and other held documents do not print 115

- envelope seals when printing 135
- incorrect margins 97
- jammed pages are not reprinted 138
- job prints from the wrong tray 114
- job prints on the wrong paper 114
- paper frequently jams 137
- print jobs do not print 112
- slow printing 113
- troubleshooting, print quality
 - blank or white pages 90
 - crooked print 102
 - dark print 91
 - fine lines are not printed correctly 93
 - folded or wrinkled paper 94
 - gray background on prints 95
 - horizontal light bands 105
 - light print 97
 - mottled print and dots 99
 - paper curl 100
 - repeating defects 111
 - skewed print 102
 - solid black pages 103
 - text or images cut off 104
 - toner easily rubs off 105
 - vertical dark bands 108
 - vertical dark lines or streaks 109
 - vertical dark streaks with print missing 110
 - vertical light bands 106
 - vertical white lines 107

U

- Universal paper
 - configuring the settings 20
- unlinking trays 23
- updating firmware 25
- USB printer port 19
- using genuine Lexmark parts and supplies 70
- using the control panel 11

V

- vertical dark bands 108
- vertical dark lines on prints 109
- vertical dark streaks 110

- vertical light bands 106
- vertical streaks on prints 109
- vertical white lines 107
- viewing
 - reports 70
- volatile memory 32
 - erasing 31
- volatility
 - statement of 32

W

- white lines 107
- white pages 90
- Wi-Fi Direct
 - configuring 28
- wireless network
 - connecting the printer to 26
 - Wi-Fi Protected Setup 27
- wireless networking 26
- Wi-Fi Direct
 - enabling 28
 - printing from a mobile device 34
- Wi-Fi network
 - deactivating 29
- Wi-Fi Protected Setup
 - wireless network 27
- wrinkled paper 94